

# ServiceLine

The Official Publication of the South Dakota Association of Rural Water Systems

**HOW TO PREVENT  
YOUR WATER STORAGE  
TANK FROM FREEZING**

**NEW CERTIFICATION  
CLASS REGISTRATION  
WEBSITE**

**HOW TO DETECT AND  
THAW FROZEN SEWER  
SERVICE LINES**

**MANAGE YOUR SDARWS  
MEMBERSHIP ONLINE**

**2023 ATC  
JANUARY 10-12  
PIERRE, SD**

**ATC METER  
CHALLENGE  
JANUARY 11**

**RURAL WATER  
TASTE TEST  
CONTEST**

# WHEN YOU NEED POWER, WE ARE THERE FOR YOU

*NEW OR USED, ANY SIZE OR SHAPE, IN ANY REGULATORY ENVIRONMENT*

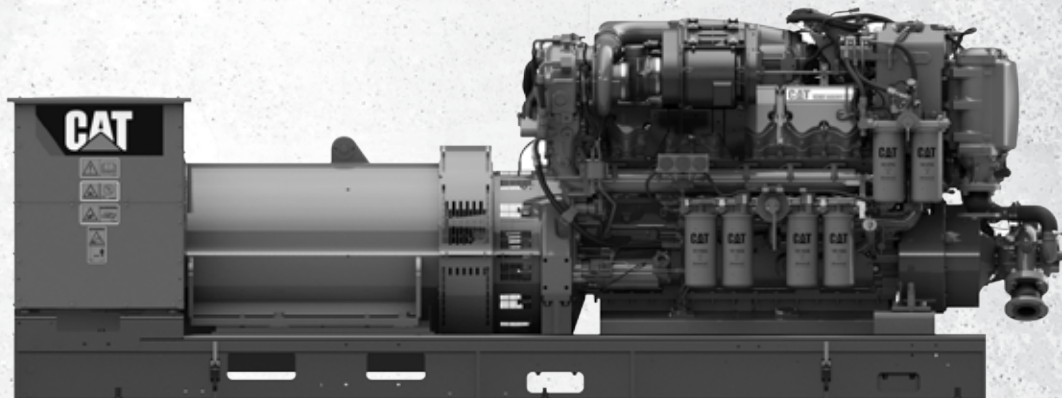

877.365.8114 | BUTLERMACHINERY.COM

Butler 

**Bartlett  
& West**

## Engineering water solutions for community growth.

Clean, safe and reliable water is a basic building block of a modern community. Residents and industry depend on your system. You need proactive communications regarding system needs and innovative, comprehensive solutions. As a national leader with long-time relationships in water-focused services, Bartlett & West is your ally for success.

5900 S. Western Ave., Ste. 101 ■ Sioux Falls, SD  
(888) 200-6464 ■ [www.bartlettwest.com](http://www.bartlettwest.com)



# IN THIS ISSUE



## SDARWS CORPORATE PARTNERS

Marsh & McLennan Agency, Inc.  
 Risk Administration Services  
 Dakota Pump & Control  
 Dakota Supply Group  
 Treatment Resources, Inc.  
 Banner Associates  
 Bartlett & West, Inc.  
 DGR Engineering  
 Maguire Iron, Inc.  
 Core and Main  
 Dakota Pump Inc.  
 CoBank  
 Milbank WinWater  
 AE<sub>2</sub>S  
 ISG  
 Brosz Engineering  
 Hawkins  
 Respec  
 Jetline Sales & Service

- 5** From The SDARWS President
- 6** New Certification Class Registration Site
- 7** Operator Certification Training Class And Exam Schedule
- 9** SDARWS Staff Directory
- 11** Manage Your Membership on Our New Online Portal
- 12** 2023 Annual Technical Conference Information
- 14** Water Taste Test Contest Details
- 15** ATC Registration Information
- 16** 2023 ATC Schedule
- 19** First Annual Water Meter Challenge Info
- 21** How to Prevent Your Water Storage Tank From Freezing
- 23** What Led Me Here
- 25** Are We Ready For Winter?
- 27** How to Detect and Thaw Frozen Sewer Service Lines
- 29** SDARWS Conferences And Events
- 31** Certification Questions
- 33** 2022 Leadership Seminar Highlights
- 34** DSS Water/Wastewater Assistance

**Cover Photo: Devil's Bathtub. Photo credit Jennifer Bame**

ServiceLine is published bi-monthly by the South Dakota Association of Rural Water Systems. The contents of this publication may not be reproduced by any means, in whole or in part, without the prior written consent of SDARWS. SDARWS reserves the right to reject or edit any manuscripts received for publication. All submissions become the property of the South Dakota Association of Rural Water Systems unless otherwise specifically stated in this publication. Statements of fact and opinion are the responsibility of the authors alone and do not imply an opinion on the part of the South Dakota Association of Rural Water Systems. Advertisements and editorials do not represent official policies of the Association. Acceptance of advertising by SDARWS does not constitute endorsement of the advertiser, its products or services, nor does SDARWS make any claims or guarantees as to the accuracy or validity of advertisers' claims.

To submit editorial or advertising content, or to update your mailing information, please contact Jennifer Bame at 605-556-7219 or email [jbame@sdarws.com](mailto:jbame@sdarws.com).

**SOUTH DAKOTA ASSOCIATION OF RURAL WATER SYSTEMS**

P.O. Box 287, Madison, SD 57042 • Phone 605-556-7219, Fax 605.556.1497 • email: [info@sdarws.com](mailto:info@sdarws.com) • [www.sdarws.com](http://www.sdarws.com)  
Copyright 2022

# Winwater™

COMPANY

**S. Hwy. 15 • P.O. Box 350  
Milbank, SD 57252  
1-800-743-2972  
Fax 605-432-5447**

*Large enough to handle any job,  
but small enough to care about yours.*

- WATER PRODUCTS
- INDUSTRIAL PIPING
- WATER METER SYSTEMS
- PUMP SYSTEMS
- GEO TEXTILE FABRIC
- ROAD CASTINGS



**QUALITY  
ENGINEERING  
SOLUTIONS FOR  
RURAL WATER  
PROJECTS**

MASTER PLANNING  
ASSET MANAGEMENT  
HYDRAULIC MODELING  
CAPACITY ANALYSIS  
STORAGE RESERVOIRS  
PUMPING STATIONS  
PIPELINES  
TREATMENT FACILITIES  
CONSTRUCTION SERVICES

MITCHELL, PIERRE, SIOUX FALLS, STURGIS  
SOUTH DAKOTA  
broszeng.com

**Brosz**  
ENGINEERING, INC.



# FROM THE SDARWS PRESIDENT

RON GILLEN, SDARWS PRESIDENT

## NEW SDARWS CORPORATE PARTNERS

We would like to introduce our newest Corporate Partners: RESPEC, and Jetline Sales & Service. RESPEC is located in Rapid City and specializes in innovating mission-critical solutions that enhance client success through integrated consulting and IT services. You can find more information about their services at [respec.com](http://respec.com). Jetline Sales & Service is located in Kensington, Minnesota and provides advanced and innovative Rausch USA products for pipe inspection and point repair that match the ever-changing and evolving demands of success-oriented customers. You can visit them online at [jetlinesales.com/](http://jetlinesales.com/)



## 2023 ANNUAL TECHNICAL CONFERENCE

Our Annual Technical Conference is approaching fast, and the staff at South Dakota Rural Water are busy behind the scenes gearing up for the event which kicks off Tuesday, January 10th at the Best Western Ramkota in Pierre. The full agenda can be found on pages 13-19 in this issue of *ServiceLine*.

Online registration is open, so check [sdarws.com/ATC](http://sdarws.com/ATC) for everything you need to know – agendas, hotel information, and news regarding the upcoming conference.

## ATC KEYNOTE SPEAKER - HOLLY HOFFMAN

The third time is hopefully a charm to welcome our keynote speaker Holly Hoffman after COVID-19 prevented her attendance in 2021 and 2022. Holly was the last remaining member of the Espada Tribe and the last woman standing on Season 21 of CBS' hit reality show "Survivor: Nicaragua." Through that experience, and others throughout her life, Holly was inspired to share her message of survival. More information about Holly can be found on page 15.

## WATER TASTE TEST CONTEST

This year's Exhibit Hall will feature a public judging of the top three finalists in the SD Rural Water Taste Test. The winner chosen at this taste test will go on to represent South Dakota in the National Rural Water Taste Test held at the Rural Water Rally in Washington, DC in February of 2024. If your water system is interested in participating in the taste test, please make sure that they bring a quart-sized glass jar filled with water from your water system to the Registration Desk by 2:00pm on Tuesday, January 10th.

## FIRST ANNUAL ATC METER CHALLENGE

This year we are excited to host the first annual ATC Meter Challenge. This competition will test and measure how quickly, totally, and accurately you can assemble a working water meter. There is no cost to participate, and there are cash prizes for the top three. Timed trials will take place on Wednesday, January 11th from 8:00 AM - 3:00 PM at the SD Rural Water Booth. The top 5 finalists will compete at 4:30 PM in the Exhibit Hall. A full list of rules can be found at [sdarws.com/meterchallenge](http://sdarws.com/meterchallenge).

## 2022 RURAL WATER RALLY

South Dakota Rural Water does many things, and one of the most important benefits to our rural water membership relates to our legislative efforts. Every year the National Rural Water Association hosts a Rural Water Rally in Washington D.C. to further the work of providing drinking water and wastewater services to rural communities. Rural Water professionals, leaders and customers from every state attend the rally to thank their Senators and Representatives for their support and encourage them to further support the goals and needs of the Rural Water Industry. The Rally provides your Association the opportunity to meet directly with our congressional delegation one-on-one to discuss concerns of SDARWS members and other systems, as well as with their staffers, and USDA.

We invite you to join us February 7-9 at the Hyatt Regency on Capitol Hill. For more information, visit NRWA's Rally page at: [nrwa.org/rally](http://nrwa.org/rally). Room reservations can be made at the Hyatt Regency by calling 202-737-1234. If you have any questions about attending this year's event, please call the SDARWS office at 605-556-7219. We would love to have you join us on the Hill! 💧

# REGISTER FOR SDARWS CERTIFICATION CLASSES

The South Dakota Association of Rural Water Systems has upgraded to a new website and class registration software. This move will allow us to better track class attendees and certification hours.

## 1. Navigate to **SDARWS.COM**

- Bring your cursor to the **TRAINING & EVENTS** header, and hover over **CERTIFICATION** and you'll see **TRAINING CALENDAR** pop up
- or click on the **CERTIFICATION TRAINING** button
- or navigate to **WEB.SDARWS.COM/EVENTS**



## 2. Browse for classes by clicking on the arrows to navigate the calendar

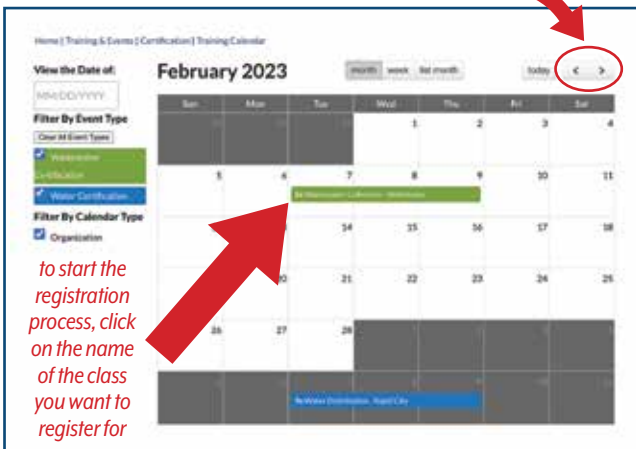

Click this button for more information on the class

## 3. Fill out the form with the name and information of the person filling out the form, and click **NEXT**

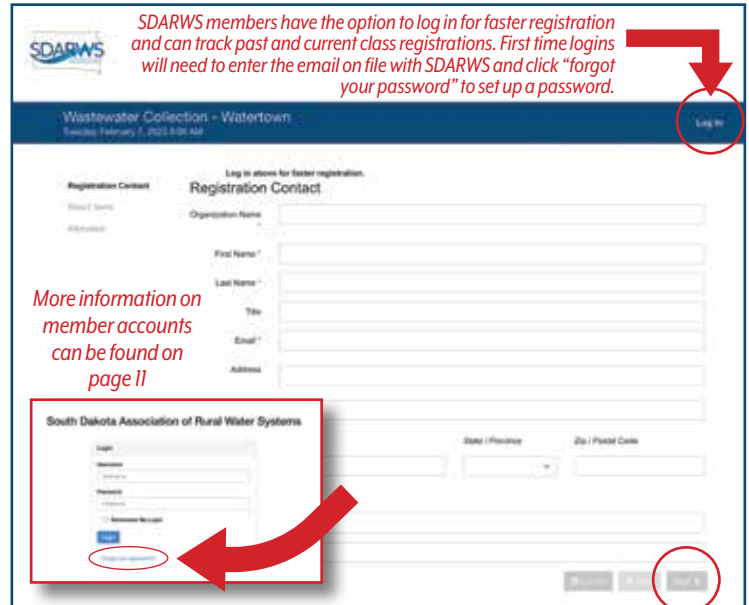

## 4. In the quantity box, enter the number of people you are registering for this class, and then click **NEXT**



## 5. Fill out the information for each attendee. Make sure to click the **I AM NOT A ROBOT** button, and then click the green **SUBMIT REGISTRATION** button. An email confirmation with registration details will be sent to each email address provided during the registration process.

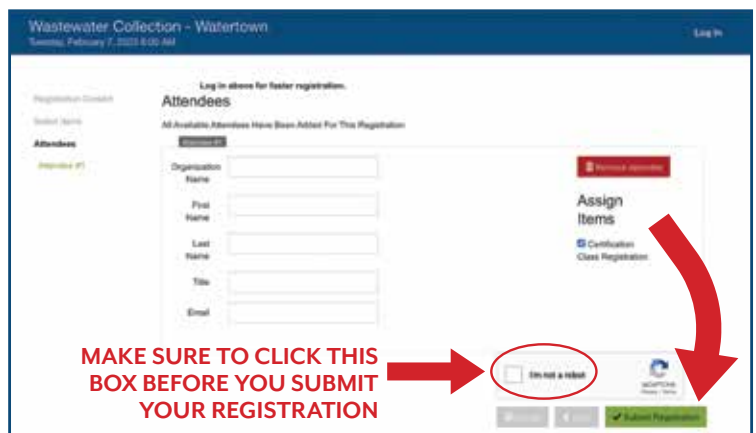



# OPERATOR CERTIFICATION TRAINING AND EXAMS

Course Name	Date	Location
Basic Wastewater Treatment	December 6-8, 2022	Rapid City Ramkota - Rushmore Room
OpCert Exam	December 8, 2022 @ 1:00 PM	Rapid City Ramkota - Rushmore Room
Basic Water Treatment	January 24-26, 2023	Rapid City Ramkota - Rushmore Room
Wastewater Collection	February 7-9, 2023	Watertown Ramkota
Water Distribution	March 7-9, 2023	Rapid City Ramkota - Rushmore Room
Basic Water Treatment	March 21-23, 2023	Watertown Ramkota
Basic Wastewater Treatment	April 4-6, 2023	Sioux Falls Ramkota - Harvest Room
Small Water Treatment Workshop	April 27, 2023	Rapid City Ramkota
Intermediate Water Treatment	May 2-4, 2023	Aberdeen Ramkota
Advanced Water Treatment	May 23-25, 2023	Rapid City Ramkota - Rushmore Room
Stabilization Pond Workshop	June 1, 2023	Huron - Huron Events Center

*Classes start at 8:00 AM Tuesday through Thursday.*

*Classes end at approximately 4:30 PM on Tuesday and Wednesday, and noon on Thursday.*

*One-day Workshops start at 8:00 AM and end at 4:30 PM.*

*The Stabilization Pond class deals strictly with ponds/lagoons and is the best class for preparing to take the Small WW Exam. The Basic WW Treatment class deals with all types of wastewater treatment other than ponds/lagoons and is the best class for preparing to take the Class I WW Treatment exam. Small Systems that use ponds/lagoons for treatment can come into compliance with the Operator Certification Law by passing either the Small WW System exam or the Class I WW Treatment Exam.*

*Water systems serving less than 500 individuals and use wells as its source can come into compliance by passing the Small Water Treatment exam. Larger systems must pass the Class I Water Treatment exam or higher depending on the facility classification.*

## **EXAM INFORMATION**

All exams cost \$60.00 and must be taken “in-person.”

Any exam can be taken at an exam session. You can take more than one exam at an exam session; however, the exam session remains at three hours long.

All exam applications are due no later than two weeks prior to the exam date.

Questions regarding exams can be directed to Tammie Hill with DANR at 605-773-3577.

## **DANR Operator Certification website:**

[danr.sd.gov/OfficeOfWater/OperatorCert/default.aspx](http://danr.sd.gov/OfficeOfWater/OperatorCert/default.aspx)

## **STUDY MATERIALS**

DANR has water exam study material to lend to operators. These include manuals from California State:

- *Water Distribution System Operation and Maintenance*
- *Small Water System Operation and Maintenance*

## **TRAINING CLASSES**

Certification Training Classes are conducted by the South Dakota Association of Rural Water Systems. **These classes are presented at no charge.** Certified Operators can obtain contact hours for attending all of the above classes.

For more information on certification training classes, please contact Bill Thorson at 605-556-7219 (office) or 605-201-0170 (cell).

## **Register for training classes online at:**

[web.sdarws.com/events](http://web.sdarws.com/events)

**For Study materials, visit: [www.abccert.org/testing\\_services/ExamReferences.asp](http://www.abccert.org/testing_services/ExamReferences.asp)**

**REGISTER FOR CLASSES ONLINE: [web.sdarws.com/events](http://web.sdarws.com/events)**



engineering  
a better  
community

water | wastewater

Mni Wasté Water Supply Project | Cheyenne River Sioux Reservation | North Central SD

Brookings | Sioux Falls | Vermillion | Rapid City | Milbank  
605.692.6342 | Toll Free 1.855.323.6342  
www.bannerassociates.com

**BANNER**  
engineering a better community

# DAKOTA PUMP

## WATER PUMP STATIONS

- Modular Water Booster Stations
- Grade Mounted Water Booster Stations
- Water Booster Pump Stations
- Water Control Vaults

## WHY PREFABRICATED?

- Fully Factory Tested
- Ease of Installation
- Simplified Design
- Single Source Responsibility

## SEWAGE PUMP STATIONS

- Wet Well Mounted Lift Stations
- Flood Suction Lift Stations
- Self-Priming Lift Stations
- Obround Package Pump Stations

## PROACTIVE PUMP STATION SALES, MAINTENANCE AND INSPECTION

WE PROVIDE  
SOLUTIONS  
BUILT ON  
RELATIONSHIPS

## DAKOTA PUMP OFFICES

### MITCHELL

25524 413th Ave, Mitchell, SD 57301  
MAIN 605.996.6636 | CELL 605.770.9371

### RAPID CITY

12065 Quaal Rd, #99, Black Hawk, SD 57718  
MAIN 605.996.6636 | CELL 605.430.2862

### WATERTOWN (K&P PUMPS)

800 33rd St SW, Watertown, SD 57201  
MAIN 605.753.0072 | CELL 605.881.1586

PROACTIVE PUMP STATION SALES, MAINTENANCE AND INSPECTION | VISIT [DAKOTAPUMP.COM](http://DAKOTAPUMP.COM)



# SDARWS STAFF DIRECTORY



**KURT PFEIFLE**

*Executive Director*

kpfeifle@sdarws.com  
605-204-0125



**MIKE MOELLER**

*Technical Assistance  
Training Specialist*

mmoeller@sdarws.com  
605-270-4989



**JEREMIAH CORBIN**

*Field Program Supervisor*

jcorbin@sdarws.com  
605-270-3894



**ALLEN KOCMICH**

*East River Circuit Rider*

akocmich@sdarws.com  
605-201-6026



**ROBYN BROTHERS**

*Office Manager*

rbrothers@sdarws.com  
605-556-7219



**PAUL DORWART**

*East River Circuit Rider*

pdowart@sdarws.com  
605-201-9568



**JENNIFER BAME**

*Communications &  
Marketing Coordinator*

jbame@sdarws.com  
605-556-7219



**WYATT HIX**

*West River Circuit Rider*

whix@sdarws.com  
605-641-4557



**STEVE ATTEMA**

*Safety Training  
Specialist*

sattema@sdarws.com  
605-270-1766



**DANNY AYERS**

*Wastewater Technician*

dayers@sdarws.com  
605-291-2299



**BILL THORSON**

*Certification Training  
Specialist*

bthorson@sdarws.com  
605-201-0170



**GLEN OLENE**

*Wastewater Technician*

golene@sdarws.com  
605-245-6488



**JEFF FOSSUM**

*Technical Assistance  
Training Specialist*

jfossum@sdarws.com  
605-201-9561



**KEVIN CHRISTENSON**

*Source Water Protection  
Specialist*

kchristenson@sdarws.com  
605-641-1923



# Trusted. Professional. Solutions.

At DGR Engineering, we know about water and how important it is to everyday life. After all, we've been working with it since 1952. We provide our clients with solutions they can trust, covering all types of water issues from supply, treatment, storage and distribution, to wastewater treatment, collection, lift station and sewer rehab.

Call us today to discuss solutions for your next project.



Sioux Falls, SD  
Rock Rapids & Sioux City, IA  
**800-446-2531**



## COMMITTED TO MAKING YOUR WORKPLACE SAFER

We're more than a workers' compensation insurance policy provider. We're your partner in driving injury prevention.

RAS has been the endorsed Work Comp carrier for the SD Rural Water Association for over 10 years.



**Our association agency partner:**  
Justin Overman  
Marsh & McLennan Agency, LLC  
605.339.3874

RASCompanies.com  
800.732.1486

# MANAGE YOUR MEMBERSHIP ON OUR NEW ONLINE PORTAL

Our new website is powered by MemberClicks by Personify, the association industry's most powerful Association Management Software system. Our website offers many self-service and exclusive benefits that only members and/or their employees can take advantage of. To ensure only members receive these benefits, these areas of our site require a valid log in. This guide will teach you how to log in and update your information, as well as take advantage of as many benefits as possible. The more you update and personalize your membership, the more value you will receive from us!



## WHAT CAN I DO ON THE ONLINE PORTAL?

- Update your contact information (plus organization information if you're the main contact or an editor)
- Access members only content
- View your benefits, CEUs/certificates, and more
- Upload media (company logo, staff pictures, directory photo gallery and video)
- Change your password

## LOG IN TO TAKE CONTROL OF YOUR MEMBERSHIP

- You will need to use your username and password to gain access to our private Members Only Area.
- Your username is the email address we have on file. If this is your first time logging in, you will need to click 'Forgot your password' to set up a new password.

## EDIT THIS PROFILE

This link will open a page that allows you to update much of the information on your profile. If you are an Editor for your related organization(s), you can click 'Switch Profile' at any time to edit additional profiles. This helps us ensure we always have the latest information about you and your business.

**You can edit the following information:**

- Name, address, and other basic contact information
- Directory Listing category and descriptions
- Relationships you have to other profiles (including adding new profiles you are related to)
- Social media accounts
- Name, address, and other basic contact information
- If you have the right permissions, you can also edit the profiles related to your organization. You can add new staff, update current staff, or remove former staff

Once you make changes (and hit SAVE), they are submitted for approval by SDARWS.

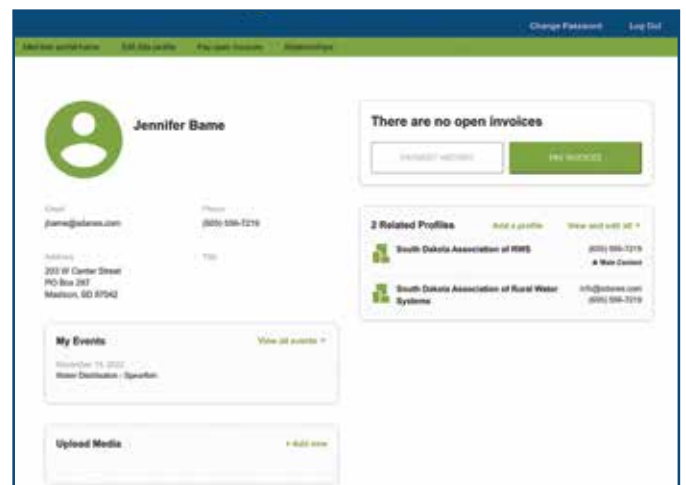

## VIEW BENEFITS, CEUs/CERTIFICATES, AND MORE!

- From the home page of your profile and any related profiles (for main contacts and editors), you can view event history, certifications, CEUs, committee involvement, and member benefits. *(Please note that any CEUs or certificates earned, or any event history before November 2022 will not be available).*
- We are working on expanding the member offerings on our online portal - so stay tuned for more information!

# Seeing success from your **PERSPECTIVE**

“We know your goals are bigger than just the project at hand. We’re invested in your overall best interest.”

*Dustin Dale, PE, AE2S Engineer*



Water Engineering and Beyond

*Award-Winning Best Place to Work*



## ***When It Comes To Waterworks, There Can Be A Lot Of Pressure.***

To succeed, you need a partner that makes your job easier. With Dakota Supply Group, you get more than just pipe and products:

▶ Contact us today to learn more about how we can help you.



***DSG***  
**DAKOTA SUPPLY GROUP**  
*For all the right connections!*

FARGO, ND ▶ [800] 342-4676  
BISMARCK, ND ▶ [855] 337-9258  
SIOUX FALLS, SD ▶ [800] 660-5531  
RAPID CITY, SD ▶ [800] 660-5538  
BURNSVILLE, MN ▶ [800] 325-0514

[www.dakotasupplygroup.com](http://www.dakotasupplygroup.com)

# ATC 2023

## South Dakota Association of Rural Water Systems ANNUAL TECHNICAL CONFERENCE

### NEW FOR 2023!

The **AWARDS BANQUET** is now on Tuesday, January 10 @ 12:00 PM, followed by Keynote Holly Hoffman in Gallery A-B-C.

**ULTIMATE METER CHALLENGE** - How fast can you assemble a working water meter? Fastest times win prizes! More info on page 19.

Thursday's **LEGISLATIVE OPEN FORUM** now includes a sit-down breakfast @ 7:30 AM.

### REGISTER ONLINE!

Register by December 16, 2022 and save \$25 off your registration or \$50 off your booth. You can register online at [sdarws.com/ATC.html](http://sdarws.com/ATC.html)

### CLIENT MEETING ROOMS

We have a limited number of rooms available for client meetings. Call 605-556-7219 to reserve.

### HOTEL INFORMATION

DAYS INN – 605-224-0411

GOVERNOR'S INN – 605-224-4200

HOLIDAY INN EXPRESS – 605-223-9045

BAYMONT INN & SUITES – 605-224-4140



## JANUARY 10-12, 2022

### PIERRE RAMKOTA HOTEL & CONVENTION CENTER

PREMIER ATC SPONSOR



REGISTER ONLINE: [sdarws.com/ATC.html](http://sdarws.com/ATC.html)

# DOES YOUR SYSTEM HAVE THE BEST WATER IN SOUTH DAKOTA?

ENTER THE SD RURAL WATER TASTE TEST CONTEST AT THE 2023 ATC!



## RULES:

- Bring your sample to the ATC registration table by 2:00 PM on Tuesday, January 10th.
- Samples must be submitted in a glass jar quart size or larger labeled with your system name.
- No water system can represent more than one entry from their system.
- Systems submitting samples must be members of SDARWS and meet DANR approval by having no violations of bacteriological testing or chemical monitoring for two years prior to the Taste Test.

## JUDGING CRITERIA:

A panel of judges will be selected to choose the winners. Judges will consider:

- Taste
- Clarity
- Odor

## PRIZES:

First place will represent all of South Dakota in the National Drinking Water Taste Test in Washington, DC in February 2024, an art-glass trophy, two Full-Conference registration passes for the 2024 Annual Technical Conference, recognition in ServiceLine magazine, and bragging rights for the next year!

# Holly Hoffman

## 2023 ATC KEYNOTE SPEAKER



**SEE  
HOLLY  
LIVE!**  
TUESDAY, JAN. 10<sup>TH</sup>  
KEYNOTE: 1:00 PM  
BREAKOUT: 3:00 PM

Holly Hoffman was the last remaining member of the Espada Tribe and the last woman standing on Season 21 of CBS' hit reality show "Survivor: Nicaragua." Through that experience, and others throughout her life, Holly was inspired to share her message of survival.

A professional motivational speaker and the author of "Your Winner Within" and "Write Yourself a Note," Holly acknowledges that life is made up of challenges, and we are oftentimes faced with situations that seem insurmountable. But within each of us is an ability to focus our thoughts, emotions, and energy to succeed – if only we have the knowledge, tools, and discipline to do so.

A native of South Dakota, Holly's writing and speaking not only offer encouragement and optimism but a roadmap for self-discovery and spiritual enlightenment. Readers and audience members alike walk away inspired to light the fire of successful living within themselves.

Today, Holly is a member of the National Speaker's Association, a recipient of the Certified Speaking Professional designation, and travels across the country and internationally speaking to a wide variety of corporations, associations, universities, schools and women's organizations. Holly inspires her audiences to take opportunities and focus on faith, attitude, determination, confidence, desire and perseverance.

## CITY OF PIERRE WATER TREATMENT PLANT TOURS



Three tours available. Sign up at the AE2S booth. Tours are limited to the first 20 participants. Attendees will be walking from the Ramkota to the facility.

## ATTENDEE INFORMATION

### MEMBER REGISTRATION

**FULL CONFERENCE:** \$275 (Early Bird) | \$300 after 12/16/22  
**TUESDAY ONLY:** \$155 (Early Bird) | \$180 after 12/16/22  
**WEDNESDAY ONLY:** \$205 (Early Bird) | \$230 after 12/16/22  
**AWARDS BANQUET:** \$30 (Early Bird) | \$35 after 12/16/22  
**SPOUSE:** \$20 (Early Bird) | \$25 after 12/16/22

### NON-MEMBER REGISTRATION

**FULL CONFERENCE:** \$365 (Early Bird) | \$390 after 12/16/22  
**TUESDAY ONLY:** \$230 (Early Bird) | \$255 after 12/16/22  
**WEDNESDAY ONLY:** \$300 (Early Bird) | \$325 after 12/16/22  
**AWARDS BANQUET:** \$35 (Early Bird) | \$40 after 12/16/22

## EXHIBITOR INFORMATION

### HALLWAY BOOTH

*(Tuesday & Wednesday)*

**\$550 Early Bird | \$600 after 12/16/22**

### HALLWAY BOOTH SCHEDULE

**Setup:** Tuesday, January 10th – 9:00am - 12:00pm

**Exhibit:** Tuesday, January 10th – 12:00pm - 5:00pm; Wednesday, January 11th – 7:30am - 5:00pm with the option to stay up until 8:00pm in Hallway, or move to Exhibit Hall by 4:00pm if space allows

**Tear Down:** Wednesday, January 11th – 5:00pm (Hallway Only) – 9:00pm (Exhibit Hall)

### EXHIBIT HALL BOOTH

*(Wednesday Only)*

**\$450 Early Bird | \$500 after 12/16/22**

### EXHIBIT HALL BOOTH SCHEDULE

**Setup:** Wednesday, January 11 – 9:30am - 1:30pm

**Exhibit:** Wednesday, January 11 – 4:00pm - 8:00pm

**Tear Down:** Wednesday, January 11 – 8:15pm - 9:00pm

*Every booth comes with full conference registrations for two individuals.*

*Corporate Partners have the option of a second booth. Please call 605-556-7219 with questions.*

### PIERRE RAMKOTA HOTEL & CONVENTION CENTER

920 WEST SIOUX AVENUE • PIERRE, SOUTH DAKOTA

### FOR MORE INFORMATION, VISIT:

[sdarws.com/atc.html](http://sdarws.com/atc.html)



**JANUARY 10-12, 2023 | RAMKOTA HOTEL**  
 920 W. SIOUX AVENUE, PIERRE, SOUTH DAKOTA

**TUESDAY**

- 8 AM – 4 PM REGISTRATION DESK OPEN
- 8 AM – 2 PM WATER TASTE TEST REGISTRATION
- 8 AM – 4 PM WATER PAC RAFFLE – LOBBY AREA

**10:00 AM**

- GALLERY D-E** CATCH LEAKS BEFORE THEY CATCH YOU!  
 –Jo-El Moore, Kamstrup Water Metering LLC
- GALLERY F** MONOFORM+  
 –Ryan Hom, HK Solutions Group
- GALLERY G** CERTIFIED STENNER TECHNICIAN SERVICE REPAIR TRAINING  
 –Mike Pontrelli, Stenner Pump Company

**10:45 AM**

- GALLERY D-E** THE EVOLUTION OF UTILITY LOCATING, TRACER WIRE SPECIFICATIONS, PRODUCTS  
 –Joe Rubbelke, Utility Logic
- GALLERY F** CAPTURING SEDIMENT ON THE GO, ENABLING CLEAN WATER TO FLOW  
 –Corydon J. Coppola, CPESC, Flo Water LLC
- GALLERY G** CERTIFIED STENNER TECHNICIAN SERVICE REPAIR TRAINING  
 –Mike Pontrelli, Stenner Pump Company

**12:00 PM**

- GALLERY A-B-C** AWARDS LUNCHEON



**AWARDS LUNCHEON SPONSOR**



**EDUCATIONAL SESSIONS SPONSOR**

**1:00 PM**

- GALLERY A-B-C** KEYNOTE ADDRESS  
 –Holly Hoffman

**2:30 PM - BREAK TABLE**

**3:00 PM**

- GALLERY D-E** WATER SERVICE LATERAL FITTINGS AND METER APPURTENANCES  
 –Calvin Williams, A.Y. McDonald Mfg. Co.
- GALLERY F** WASTEWATER EFFLUENT MONITORING AND LIMITATIONS OF DISSOLVED SOLIDS  
 –Rachel Kloos, ISG
- GALLERY G** WHAT'S THE RIGHT SCADA SOLUTION FOR YOUR SYSTEM  
 –Damon Chmela, PE, AE2S
- LEWIS & CLARK** WHEN DEMAND EXCEEDS AVAILABILITY: WHERE WILL THE EXTRA WATER COME FROM?  
 –Jay Gilbertson, East Dakota WDD
- AMP. II** KEYNOTE BREAKOUT  
 –Holly Hoffman

**3:45 PM**

- GALLERY D-E** THE IMPORTANCE OF LARGE METER HEALTH  
 –Kali Kocdemir, Olea Edge Analytics
- GALLERY F** MAGNETIC ION EXCHANGE SYSTEMS PRE-TREATMENT  
 –Craig Steve, IXOM Watercare
- GALLERY G** THE COST OF DOING NOTHING  
 –Dewey Prinzing, KLM Engineering

*This schedule is tentative and subject to change.*



## WEDNESDAY

8 AM – 4 PM	REGISTRATION DESK OPEN
8 AM – 7 PM	WATER PAC RAFFLE – LOBBY AREA
8 AM – 3 PM	METER CHALLENGE PRELIMINARIES – SDARWS BOOTH

### 8:00 AM

LEWIS & CLARK	WATER SYSTEM SUSTAINABILITY & IMPACTS ON AFFORDABILITY – Jared Huibregtse, Bartlett & West
L. FRANCIS CASE	CMAR PROJECT DELIVERY – Darin Pfingsten, PKG
AMP II	IMPORTANCE OF EFFICIENTLY, AND EFFECTIVELY, METERING WATER SYSTEMS WITH NEW AND DIFFERENT TECHNOLOGIES – Matt Kosorok, Metron-Farnier Smart Water Meters

### 8:15 AM

AMP I	<b>48TH ANNUAL MEMBERSHIP MEETING</b> <i>This is the Official Membership Meeting of the South Dakota Association of Rural Water Systems. Delegates and Alternates are encouraged to attend. Pre-Assigned seating arrangements have been reserved based on the number of voting members per system.</i>
-------	---

### 8:45 AM

LEWIS & CLARK	AMMONIA AND MANGANESE – WHAT NOW? – Julie Sievers, ISG
L. FRANCIS CASE	TOWERS – Chad Edwards, Maguire Iron
AMP II	TRANSITION FROM WELL WATER TO TREATED SURFACE WATER – PIERRE CASE STUDY – Delvin DeBoer, AE2S

### 9:30 AM - BUTLER CAT BREAK TABLE

### 10:00 AM

LEWIS & CLARK	REGULATORY UPDATE – State Plumbing Commission
L. FRANCIS CASE	METERS – Farrell Anderson, Metering & Technology
AMP I	<b>RURAL WATER CENTER ANNUAL MEETING</b> <i>This is the Official Membership Meeting for Rural Water Center</i>
AMP II	CYBER SECURITY FOR WATER & WASTEWATER – Anthony Bramante, In Control, Inc.

### 10:45 AM

LEWIS & CLARK	SD GROWTH – LET'S DO IT RIGHT – Terry Wright, ISG
L. FRANCIS CASE	OVERVIEW OF WATERSMART – Michelle de Leon, US Bureau of Reclamation
AMP II	FUNDING CAPITAL RENEWAL – WHY IT'S NOT JUST ABOUT FUNDING RESERVES – Miranda Kleven, AE2S

### 1:00 PM

LEWIS & CLARK	ISO CREDIT SUPPLY SYSTEMS – Randy Downs & Rob Holso, Verisk
L. FRANCIS CASE	EARTHTEC QZ FOR MUSSEL CONTROL IN ST. PAUL, MINNESOTA – Paul J. Besenti, Earth Science Labs/EarthTec
AMP I	LEGISLATIVE PANEL – Staff of Senator Thune, Senator Rounds, and Representative Johnson
AMP II	SRF UPDATE – Mike Perkovich, DANR

### 1:45 PM

LEWIS & CLARK	IMPACTS OF DROUGHT ON RURAL WATER SYSTEMS – Banner Associates
L. FRANCIS CASE	CASE STUDY: FOUR CORNERS FOG & FOAM CONTROL – Lewis Titus, Titus Wastewater Solutions, Inc.

### 2:30 PM - BREAK TABLE

### 3:00 PM

L. FRANCIS CASE	VERSATILITY OF FLOATING AERATORS – Lewis Titus, Titus Wastewater Solutions, Inc.
AMP I	LEGISLATIVE PREVIEW, NRWA RALLY ORIENTATION – SDARWS
AMP II	SDWARN UPDATE – Barb Friedeman, SDWARN Board

### EXHIBIT HALL SCHEDULE

4:00 PM	EXHIBIT HALL & LEGISLATIVE RECEPTION OPENS
4:30 PM	METER CHALLENGE FINALS
7:30 PM	RURAL WATER TASTE TEST FINALS
7:45 PM	WATERPAC WINNERS ANNOUNCED

## THURSDAY

### 7:30 AM

GALLERY A-B-C	SD LEGISLATURE OPEN FORUM BREAKFAST
---------------	-------------------------------------

## SPOUSE ACTIVITIES WEDNESDAY RAMKOTA COURTYARD

8 AM - 10 AM	CONTINENTAL BREAKFAST
11 AM - 1 PM	SOUP/SANDWICH LUNCHEON

FOR MORE INFO ON WHAT TO DO/SEE IN PIERRE VISIT  
THE CHAMBER OF COMMERCE DIGITAL VISITOR CENTER  
[pierre.org/visit-pierre/digital-visitor-center/](http://pierre.org/visit-pierre/digital-visitor-center/)



ISG

## DRIVEN BY PASSION + PURPOSE

101 South Reid Street + Suite 202  
Sioux Falls, SD 57103

605.274.6401



Join Our Team!

[bit.ly/WW\\_WW\\_Jobs](https://bit.ly/WW_WW_Jobs)

### Expertise Snapshot

- Capital Improvement Plans
- Feasibility Studies
- Grants + Funding Support
- Hydraulic System Modeling + Analysis
- Industrial Wastewater
- Inflow + Infiltration Studies
- Master Planning + Facility Plans
- Permitting
- Sanitary Sewer + Wastewater Collection
- Site Selection + Surveying
- User Rate Studies
- Water + Wastewater Operations
- Wastewater Treatment
- Water Treatment
- Water Reuse

Architecture + Engineering + Environmental + Planning | ISGInc.com



## Are You Giving Wipes A Free Pass?



Water Treatment's Total Solution  
952-941-2678  
[vessco.com](http://vessco.com)



## Stop Wipes

before they get into your plant  
with a FSM Perforated Plate  
Belt Filterscreen.



- FSM<sup>®</sup> has been protecting plants for over 30 years.
- Self-adjusting auto brush.
- 85% capture 24/7.

[www.savecowaterna.com](http://www.savecowaterna.com)





*First Annual*  
**WATER METER  
CHALLENGE**

WEDNESDAY, JANUARY 11

**HOW FAST CAN YOU ACCURATELY ASSEMBLE A WORKING METER?**

*COMPETE FOR CASH & PRIZES!*

This competition is to test and measure how quickly, totally, and accurately you can assemble a working meter. All parts will be assembled to the diagram given, meter will be tested for leaks, meter will be disassembled to ensure proper assembly.

There is no cost to participate.

Timed trials will take place on Wednesday, January 11th from 8:00 AM - 3:00 PM at the SD Rural Water Booth.

The top 9 finalists will compete at 4:30 PM in the Exhibit Hall.

A full list of rules can be found at [sdarws.com/meterchallenge](http://sdarws.com/meterchallenge)



*Thank you to  
our sponsors!*



**METERING AND  
TECHNOLOGY  
SOLUTIONS**

**FERGUSON**  
WATERWORKS

**MUELLER**

# SIMPLY SEALS!

Rated to 305 psi

## FORD



No field trimming required!

- Tapping Sleeves
- Couplings
- Bell Joint Encapsulators

Fully encapsulated for the most challenging applications.

260-563-3171 • [fordmeterbox.com](http://fordmeterbox.com)



## No Inventory? No Problem!

Need help building and validating your service line inventory?

[www.120water.com/LSLI](http://www.120water.com/LSLI)



Partnering with your association to help build your path to LCR compliance.

# STRUCTURE. & INTEGRITY.

## PITTSBURG TANK & TOWER GROUP

An ESOP Company Since 1919

"100 years and still climbing"



CREWS AVAILABLE GLOBALLY



[www.pttg.com](http://www.pttg.com)

	INSPECTIONS	REPAIR	TANKS
	Wet	Code Updates	Elevated Ground
	Dry	Paint	Relocation
	ROV	Insulation	Erection
	In-Service Cleaning		Dismantles
NEW TANKS - Rick DiZinno (270) 826-9000 ext. 2601		EXISTING TANKS - Jordan Pyles (270) 826-9000 ext. 4601	



Official Dealer & Distributor For

# rausch<sub>USA</sub>



Chase Johnson 320.290.5764 | [chase@jetlinesales.com](mailto:chase@jetlinesales.com) | [www.jetlinesales.com](http://www.jetlinesales.com)



# HOW TO PREVENT YOUR WATER STORAGE TANK FROM FREEZING

**Mike Moeller,**  
**SDARWS Technical Assistance Training Specialist**

**W**ith the cold of winter closing in on us, it might be a good idea to talk about keeping your water storage tank from freezing.

In the summer months, people like to keep their tank levels as full as possible to have the added water available during the heat of the summer, but as most of you know, we only have those temperatures for a few months, and then it's back to cold and wind. Ice in a water storage tank can be very harmful to the structure, harming the internal coating, ripping at any control wires that may be used for level sensing, and, in a worst-case scenario, even causing structural damage to the tank.

One of the best ways to keep an elevated storage tank from freezing is to simply keep the water moving. In South Dakota, recirculation pumps are commonly used to keep ice to a minimum in an elevated storage tank. Water pumps from the base of the tank up a smaller pipe within the standpipe to reach the top of the water level. With enough flow from the pump, the water in the tower won't freeze. Keep in mind this means the pump would have to run all the time and may be costly to the municipality.

Heaters are another option for a water storage tank to keep the ice away. I have seen tanks, whether they be elevated or ground storage, with heaters in them. Again, this is an option to keep your tank from freezing in our frigid winter months, but it

uses electricity to power the heaters and costs the municipality to run them.

Another option is to utilize mixers to keep the ice out of your water storage tank. The mixer helps move water from the bottom of your tank to the top, keeping all the water at a uniform temperature. With the usage of water leaving the storage tank and the introduction of new water in the tank when it refills, the ice shouldn't have a chance to form.

The last way that operators in South Dakota keep their water storage tanks and towers from freezing is to adjust the fill and stop set points. This is done to keep the water moving as frequently as possible. It does work most of the time, but in the event of a long cold snap, these tanks and towers have frozen.

In conclusion, in the event your water storage tank does freeze, there are some companies out there who specialize in thawing frozen tanks with steam. It will take them some time to accomplish the thawing process, but they will get it back in operation for your system as fast as they can. ♦



**MIKE MOELLER** has worked for SDARWS since 2014. He previously worked at Dakota Pump and Control for five years, and served 30 years with the South Dakota National Guard. Mike also holds an Advanced Safety Certificate from the National Safety Council.

# ENTERPRISE SOLUTIONS FOR TOMORROW'S UTILITIES

- Customer Information and Billing System
- Financial Management
- Customer Empowerment/Mobility
- GIS Mapping System
- Meter Data Management



Central Service Association

Professional Computer Solutions



**Make us prove it.**

pcs-csa.com  
888.843.3106



## The Power of Association

Only the National Rural Water Association can bring together this unique Products & Services Portfolio designed to meet the needs of utilities.

Call 800-545-1054 for more information or visit [nrwa.org](http://nrwa.org)!

\*Availability may be limited in some states.



NRWA

# WHAT LED ME HERE

## Wyatt Hix, SDARWS Circuit Rider

I started in the water industry at an early age working on the family farm/ranch around irrigation and fixing and installing potable water lines for livestock and human consumption.

I acquired a CDL with Double, Triple, and Tanker Endorsements. I worked for Duane Olson, owner of Olson Excavating Inc., out of Rapid City. The majority of the work we did was for new construction, installing water and sewer lines, small onsite wastewater systems, leveling pads, building retaining walls, and digging footings and basements for high-end housing throughout the Black Hills. We were blessed to have one of the jobs we worked on with Morton Buildings displayed in the Morton Calendar. By working with a knowledgeable group of individuals, I was able to further my education acquiring a State of South Dakota Sewer and Water Contractor License, State of South Dakota Installer of Individual and Small On-site Wastewater Systems License, and a Pennington County On-Site Wastewater Installer License.

In the fall of the year, work took me to Wyoming to work with Travis Olson, the owner of Olson Excavating LLC out of Laramie, Wyoming. We performed river restoration and bank stabilization by installing toe wood, J hooks, cross veins, Coyote Willows, pools, and thalweg to plan specifications on the Laramie River, Encampment River, and the No Wood River. This work was funded by the Wyoming Game Fish & Parks, Trout Unlimited, NRCS, and BLM. One of my favorite projects in Wyoming was working on the Laramie Water Treatment Plant. The Laramie Water Treatment plant supplied drinking water to the town of Laramie, which was located downstream from several river restoration projects Olson Excavating LLC was working on over the years. The projects helped lower the sediment/turbidity

levels in the river.

I further expanded my certifications by acquiring a Class 1 Water Treatment Operations Specialist License and a Class 2 Water Distribution Operations Specialist License while working for the City of Sturgis. During this time, I also had the privilege

of working with and getting to know some of the SDARWS staff. Their knowledge and expertise were superb. I'm honored to be part of this great team. I thoroughly enjoy meeting water operators throughout South Dakota and learning about their systems and the unique situations they encounter.

Working with SDARWS has given me the opportunity to travel to California and Maryland for training, allowing me to network with other Rural Water Circuit Riders. I enjoy learning with and from them and hearing about the systems they support. Water plays such a vital part in our everyday lives. I am happy to work with water systems and help them continue providing safe water on the tap to

their customers. I have enjoyed meeting the state's operators and staff of water systems. I appreciate the systems that have reached out to me for assistance. I am also looking forward to meeting every one of you. Feel free to call me at 605-641-4557 for technical assistance, leak detection, line tracing, locating curb stops and valves, pipe thawing, data logging, hydrant flow testing, de-chlorinating, hydro-vac, valve spinning, and any other water issues you may have. 💧



**WYATT HIX** started his career at SDARWS in the spring of 2022 at a Circuit Rider and is based out of our Spearfish office. He holds a Class II Water Distribution, Class I Water Treatment certificate, and is a licenced Sewer and Water Contractor, Certified Installer of Individual and Small on-site Wastewater Systems, and trained in on-site Wastewater Treatment Systems Installation. Wyatt resides in Belle Fourche with his girlfriend, Misty.

# SPN & ASSOCIATES

ENGINEERS SURVEYORS GIS SERVICES

Schmucker, Paul, Nohr and Associates

2100 N. Sanborn Blvd – PO Box 398  
Mitchell, SD 57301  
Phone (605) 996-7761  
FAX (605) 996-0015  
www.spn-assoc.com

Water • Wastewater • Storm Water • Streets  
Airports • Solid Waste • Animal Waste  
Land Surveying • Site Development  
Geographic Information Systems (GIS)



**ENGINEERING EXCELLENCE  
SINCE 1961**



**ELECTRIC PUMP**



An Electric Pump Company



800-211-6432  
www.electricpump.com

115 Lipton Street  
Suite B  
Tea, SD 57064

402-333-9660  
www.mc2h2o.com



# ARE WE READY FOR WINTER?

**Jeff Fossum,**  
**SDARWS Technical Assistance Training Specialist**

**P**hev! We made it! We are done with construction-spring-summer-fall projects. All we need to do now is sit back and wait for next year's rush to hit! I bet you think that I have received my medical cannabis card! What "things" need to be accomplished before the deep winter freeze closes in on South Dakota?

Whether you are a new operator as part of the public works department or a new operator on a rural water team, listen and follow the team lead in preparation for the change of weather. But if you are the new lone operator (ranger) in town, you will need some help. Either way, I hope this article helps.

Check your (milk house) heaters; just because they are plugged in does not mean they will work when the weather gets cold. Have a spare one in the box on the shelf. The farm store is not open at midnight, but your shop is.

Ask questions about shallow services that freeze up almost every year. Be prepared this year for frozen lines! With the dry weather conditions, frost will be going further down.

Water meters that are not protected will freeze. Make sure meter pits have the insulation foam in place; we do not live in Florida. Also, reach out to the older home and manufactured homeowners and remind them to have a working heat tape and a new blanket of insulation to protect the water meter. Most systems require the homeowner to pay to replace frozen water meters.

It is vital to keep your work equipment in running order. Your work truck is useless to your system when it doesn't start on a cold morning, the water tower is empty, and it's your weekend on call! Each system has its weaknesses! If your memory is like mine, get a calendar (paper or digital) and make some reminders; at home, I call this a TO-DO LIST.

Suppose you are one of the lucky operators that have lived with construction season this year. What is on your to-do list? Have the valves been inspected one last time? Who will be most affected if the "NEW" mainline valves are not operational? You may ask why I am saying a new valve does not work – but wait, a water main break happens! Ok, so you'll go out and shut off that new valve. But during the last phase of construction, the



road crew forgot to raise that valve. Now with frost two-foot-thick, uncovering that valve is an hour project with a weed burner. Not only do you have a line to repair, but also an empty water storage tank. Let's think about shutting off that area – a worst-case scenario is that the affected planned area, you assumed, is out of water. An extra valve was inadvertently left off, and a larger-than-expected area is without water. I don't know who can complain louder – old Mrs. Anderson or Mr. Smith's dairy cows! An unexpected extended outage is more than just the inconvenience of being unable to wash clothes that day! It's an economic nightmare when a business that is totally dependent on that precious liquid cannot access it.

To sum up the question: are you ready for winter? Details do matter. The little things will get you, the operator, in the biggest troubles. Just think, instead of Mrs. Anderson and Mr. Smith knowing you by your first name, they will know you as that nice person who works at your system.

Don't forget to plan what supplies are needed for 2023 spring projects and take delivery as soon as they come in. Order times are strangely long on some products. Oh, and remember to plan your to-do list for spring! 💧



**JEFF FOSSUM** joined the SDARWS staff in February 2018. He previously worked for 32 years for the City of Canton, SD as the Water/Wastewater Superintendent. Jeff holds a Class II Water Treatment, Class II Water Distribution, Class II Wastewater Treatment and Class II Wastewater Collection. His interests include gardening, woodworking, and talking.

# WATER TOWER EXPERTS



(605) 334-9749 | MAGUIREIRON.COM |    

EXTEND THE LIFE OF YOUR WATER TANK

## TANK MAINTENANCE & NEW TANKS

- Full-Service and Custom Tank Maintenance Plans
- Interior/Exterior Tank Painting
- Interior/Exterior Sandblasting and Containment
- Interior/Exterior Tank Inspections
- Lead Abatement
- Interior Tank Cleaning and Disinfection
- Custom Tank Logos
- Chemical Cleaning
- Tank Mixing Systems
- 24-Hour Emergency Services



**CHAD EDWARDS**

South Dakota Water Tower Expert  
(605) 759-4957 | edwardsc@maguireiron.com



“We love our new website! This is the best decision we ever made!”



**RuralWaterImpact.com**

Smart Websites for Smart Water Systems™



**MunicipalImpact.com**

Smart Websites for Smart Communities™

Trusted website provider for more than 1,400 small towns and water systems across America!



Text Alerting System • Easy Updates • Secure Hosting • Free Trial • Unlimited Support • Money-Back Guarantee

**FAST LAUNCH: Get a Website in Just 3 Days! Call Today (888) 551-4815**



# HOW TO DETECT AND THAW FROZEN SEWER SERVICE LINES

**Glen Olene,**  
**SDARWS Wastewater Technician**

It is that time of the year when the warm weather days change to cold and frigid days and nights, sometimes for several days or even a week or two. Being an old operator only 12 miles from the North Dakota border, it always seems colder up here.

Here are some things to look for if you think your sewer service or water lines are freezing up or frozen up already:

- There's no running water in the sink, shower, or toilet
- Frost on your pipes under the sink in the basement
- Pipes are making strange noises, gurgling and banging
- Sewer smells in the house. This is a sign your pee trap is frozen; the smell lingers in the home. Frozen sewer and water lines can cause leaks that will damage pipes, floors, walls, and ceilings.

The first thing to do is make a checklist: Are your pipes adequately insulated inside? Wrap them with pipe insulation and secure the ends with large zip ties or electrical tape. Ensure your outside vents are adequately sealed in your basement, crawl spaces, hot water lines, and water heaters. You could turn up the temperature a little for winter and back down in summer. In frigid cold spells, a constant flow of water will not freeze.

There are ways to thaw frozen lines but never use an electric welder – burning down the house would not be good. While a house fire would thaw your frozen pipe issues, it would create many more problems for you. So always be careful when applying heat with a propane torch, heat gun, hair dryer, space heater, or sunflower heater.

Your local plumber could have other options for you to use. Run hot water through the pipes, not boiling water. You could also utilize an ice auger on a plumber's snake or a steamer that works on water and sewer lines. They do make and sell safe steamers. A pressure washer with warm water and a tip on the end also works on sewer service lines.

Last winter was a bad winter for sewer services and water lines. The best maintenance is preventive maintenance. I always try to be prepared for the worst scenario. Mother Nature is hard to predict.💧



**GLEN OLENE** joined South Dakota Association of Rural Water Systems in May of 2022. Prior to that he worked as the Public Works Director for the City of Eureka, and spent 20 years in the ARMY. Glen holds a Class I in Wastewater Collection, Class I in Stabilization Ponds, and Class I in Water Distribution. In his spare time he enjoys riding his Harley with his wife, camping, hunting, and fishing.



# Water Treatment Chemicals, Equipment and Local Service

Scan this QR code to see the Hawkins testimonial video.



800.328.5460  
wtg@hawkinsinc.com

*Customized solutions by a professionally trained team.*

### SERVICE

- Mini Bulk Delivery
- Equipment Installations
- Laboratory Testing

### WATER TREATMENT

- Potable Water
- Wastewater Treatment
- Collection Systems

### EQUIPMENT

- Chemical Injection Pumps
- Chlorination Control
- Chemical Feed Equipment

Black Hawk, SD 605.787.6881	Sioux Falls, SD 605.368.5793	Fargo, ND 701.293.9618	Washburn, ND 701.462.8588
--------------------------------	---------------------------------	---------------------------	------------------------------

## Now Hiring for Sales & Service!

Visit [www.hawkinsinc.com/careers](http://www.hawkinsinc.com/careers) for current openings and locations



Since 1913, HR Green has provided solutions that build communities and improve lives.



▶ SIOUX FALLS

▶ [HRGREEN.COM](http://HRGREEN.COM)

# SDARWS Conferences & Events



## Annual Technical Conference | January 10-12, 2023

The ATC is the annual conference of the South Dakota Association of Rural Water Systems, and is the largest water/wastewater conference in South Dakota. This event is designed to bring together water and wastewater utility systems – both large and small, municipal and rural – for sessions in operations, management, boardsmanship and governance. This conference is held every year during the first week of the South Dakota Legislative session in Pierre, SD and hosts over 500 attendees.

To learn more, visit [sdarws.com/ATC.html](https://sdarws.com/ATC.html) or email [atc@sdarws.com](mailto:atc@sdarws.com)

Pierre Ramkota Hotel & Convention Center  
920 W Sioux Ave. • Pierre, SD • 605-224-6877



## Rural Water EXPO | April 26-27, 2023

The EXPO is open to all water and wastewater utility staff, board/council members, engineers, State and Federal employees. The training will consist of twenty presentations, 30 minutes each, thus allocating ten contact hours for those individuals who are licensed operations specialists. Along with the training sessions, the EXPO will showcase many of our industry's manufacturer and supplier leaders. Many will be displaying the recent advances in technology our industry has witnessed over the past several years.

To learn more, visit [sdarws.com/EXPO.html](https://sdarws.com/EXPO.html) or email [expo@sdarws.com](mailto:expo@sdarws.com)

Rapid City Ramkota Hotel & Convention Center  
2111 N Lacrosse Street • Rapid City, SD • 605-343-8550



## Rural Water Fishing Tourney | April 28-29, 2023

The Annual Rural Water Warriors Fishing Tournament takes place at the Outpost Lodge on Cow Creek Bay in 2023. Teams consist of 2-3 people with at least one person who is a current water/wastewater, associate member or corporate partner of the SDARWS. This tournament is limited to 50 teams. There is an eight fish maximum per boat with the largest seven fish weighed, and all South Dakota fishing regulations must be followed. A mandatory rules meeting is held at 8:00pm the night before the tournament.

For more information, visit [sdarws.com/fishing-tournament.html](https://sdarws.com/fishing-tournament.html) or email [fishing@sdarws.com](mailto:fishing@sdarws.com)



## Rural Water Open Golf Tourney | July 18, 2023

The Annual Rural Water Open will take place at the Elmwood Golf Course in Sioux Falls. This tournament is open to Utility Members, Associate Members, and Corporate Partners of SDARWS. Registration is \$100/player and includes golf, cart, lunch, and awards.

For more information, visit [sdarws.com/golf.html](https://sdarws.com/golf.html) or email [golf@sdarws.com](mailto:golf@sdarws.com)

Elmwood Golf Course  
2604 W. Russell St • Sioux Falls, SD • 605-367-7092



## Leadership Seminar | November 2023

This seminar is geared towards Rural Water System Directors and covers a gamut of topics pertaining to rural water boards.

For more information, visit [sdarws.com/leadership.html](https://sdarws.com/leadership.html) or email [jcorbin@sdarws.com](mailto:jcorbin@sdarws.com)

Pierre Ramkota Hotel & Convention Center  
920 W. Sioux Ave. • Pierre, SD • 605-224-6877



# Your number one source

Top providers of creative water and wastewater solutions with over 75 years of combined experience.



[treatmentresources.com](http://treatmentresources.com) • 612 702-2692

## Special Loan Terms for SDARWS Members!

South Dakota Association of Rural Water Systems (SDARWS) has partnered with CoBank,

a national cooperative bank that serves rural America, to provide attractive financing solutions for SDARWS members. Find out about the specially negotiated terms on many loan products and bonds for water and wastewater utilities, including:



- ✓ USDA INTERIM CONSTRUCTION FINANCING
- ✓ USDA GUARANTEED LOANS AND BONDS
- ✓ LINES OF CREDIT
- ✓ DEBT REFINANCING
- ✓ TERM FINANCING



**CONTACT**  
Michael Griffiths  
Call: 720-520-6261  
Email: [griffiths@cobank.com](mailto:griffiths@cobank.com)



# CERTIFICATION PRACTICE QUESTIONS

- 1. Corrosive chemicals are usually pumped with a \_\_\_\_\_ pump.**
  - a. diaphragm
  - b. piston
  - c. plunger
  - d. rotary
- 2. Two chemical compounds that should never be stored together are calcium oxide and**
  - a. alum.
  - b. calcium hydroxide.
  - c. soda ash.
  - d. sodium hydroxide.
- 3. Routine bacteriological and chemical reports must be submitted to the appropriate regulatory agency by a utility doing the testing**
  - a. as they are completed.
  - b. the last day of each quarter.
  - c. within 14 days of the analyses.
  - d. within the first 10 days following the month of analyses.
- 4. The heat generated during lime slaking**
  - a. accelerates the slaking process.
  - b. creates caking problems with the lime feeder.
  - c. interferes with the slaking process.
  - d. should be maintained within a range of 60-90oF for best results.
- 5. If fluoride is added ahead of filtration**
  - a. some fluoride loss will occur.
  - b. problems with disinfection will occur.
  - c. increases in fluoride concentration will occur.
  - d. a precipitate will form.
- 6. If dry powdered activated carbon is transferred to a day tank in the form of a slurry, it is important that**
  - a. the tank be monitored frequently for heat generation.
  - b. the slurry be kept in suspension.
  - c. cooling towers be installed.
  - d. cathodic protection be practiced.
- 7. When using diquat or endothal for the control of aquatic plants, it is important to**
  - a. determine if the wind is favorable.
  - b. determine the appropriate waiting time before the water can be used.
  - c. shut down the treatment plant.
  - d. use approved application equipment.
- 8. The maximum contaminant level for turbidity is \_\_\_\_ NTU as measured with a nephelometer or turbidimeter.**
  - a. 1
  - b. 3
  - c. 5
  - d. 10
- 9. Your chlorinator breaks down and you decide to feed a sodium hypochlorite solution containing 15 percent chlorine as a temporary measure. Six milligrams per litre of chlorine are required for a 1.8 million gallon pumped in 18 hrs. How many gallons per hour of the hypochlorite solution will be required? Assume specific gravity 1.0.**
  - a. 2.67
  - b. 3.00
  - c. 4.00
  - d. 5.00
- 10. At least once a year a filter bed should be**
  - a. taken out of service.
  - b. restratified.
  - c. replaced.
  - d. probed for gravel displacement.



**Bridging the gap**  
between idea +  
achievement

Sioux Falls 605.977.7740  
Rapid City 605.791.6100



[hdrinc.com](http://hdrinc.com)

The Leading Distributor of Water, Sewer & Storm Drain Products & Services



**WE'RE ALL ABOUT**

*South Dakota*

When you need dependable service in the middle of the night, the eye of the storm or the center of town, you need the waterworks experts at Core & Main.

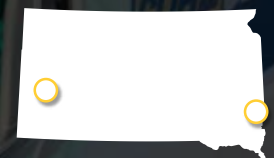

**Sioux Falls**  
2101 E 54th St N  
(605) 339-2814

**Rapid City**  
2808 E Highway 44  
(605) 716-9427

- FUSIBLE PIPING
- METERING AMR/AMI
- TREATMENT PLANTS
- STORM DRAIN
- PUMPING

Local Knowledge | Local Experience | Local Service, Nationwide®

[coreandmain.com](http://coreandmain.com)

PASD20190529





SOUTH DAKOTA RURAL WATER  
**LEADERSHIP**  
SEMINAR

# 2022 HIGHLIGHTS





# FROM THE EXECUTIVE DIRECTOR

KURT PFEIFLE, EXECUTIVE DIRECTOR

As we all know, everyone needs water to exist. However, for most people, our water is provided to us by some outside source, such as a public water supplier (PWS) such as your rural water system. In turn, PWSs pass along the costs of acquiring, treating and delivering this water, in the form of monthly water charges, to its customers. No matter how critical, some customers may, from time-to-time, have trouble paying for the water they need.

The South Dakota Department of Social Services has received funding to assist low-income individuals and families whose water/wastewater service has been disconnected or who are at risk of losing access to water service. If a water/wastewater service has been disconnected; or if the customer has been notified of pending service disconnection; or if a customer has overdue water service bills, there may be help available.

Eligibility for Water Assistance is based on the number of people and income of everyone in the home. If you have customers in need of assistance, have them contact the Community Action Agency serving your area. Applications are being accepted now.

## **Inter-Lakes Community Action**

**605-256-6518 • [www.interlakescap.com](http://www.interlakescap.com)**

serves Brookings, Clark, Codington, Deuel, Grant, Hamlin, Kingsbury, Lake, McCook, Miner, Minnehaha, and Moody counties.

## **Grow South Dakota**

**605-698-7654 • [www.growsd.org](http://www.growsd.org)**

serves Beadle, Brown, Campbell, Day, Edmunds, Faulk, Hand, Hughes, Hyde, McPherson, Marshall, Potter, Roberts, Spink, Stanley, Sully, and Walworth counties.

## **Rural Office of Community Services**

**605-384-3883 • [www.rocsinc.org](http://www.rocsinc.org)**

serves Aurora, Bon Homme, Brule, Buffalo, Charles Mix, Clay, Davison, Douglas, Gregory, Hanson, Hutchinson, Jerauld, Jones, Lincoln, Lyman, Mellette, Sanborn, Todd, Tripp, Turner, Yankton, and Union counties.

## **Western South Dakota Community Action**

**605-348-1460 • [www.wsdca.org](http://www.wsdca.org)**

serves Bennett, Butte, Corson, Custer, Dewey, Fall River, Haakon, Harding, Jackson, Lawrence, Meade, Perkins, Oglala Lakota, Pennington, and Ziebach counties.



The South Dakota Department of Social Services is dedicated to strengthening families to foster health, well being, and independence.

For more information, please visit [dss.sd.gov](http://dss.sd.gov).

## Build Your Future • Apply Today

Scan the QR code to view more information and start your application.



Applications are open year-round via:

- Electronically using RD Apply
- Through your local RD Office



# USDA WATER & WASTE WATER DISPOSAL LOAN & GRANT PROGRAM

## About the Program

This program provides funding for clean and reliable drinking water systems, sanitary sewage disposal, sanitary solid waste disposal, and storm water drainage to households and businesses in eligible rural areas.

Build Your Future • Apply Today

# Supporting Membership

## NRWA

## We are raising the bar by reinventing our individual membership.



For \$49, you can join the growing community of NRWA Supporting Members dedicated to the success and sustainability of the Rural Water industry.



Every dollar of your membership dues goes to NRWA's lobbying efforts, ensuring that small and rural water utilities and State Rural Water Associations have a voice in Washington, D.C.

### Supporting Membership Includes:

- Members-only newsletter, *NRWA Unfiltered*
- Discounts on WaterPro Conference registration and NRWA store items
- Notifications and access to industry-specific training sessions
- Valuable insight directly from key policy leaders
- Inside look at our grassroots agenda to advance water and wastewater utilities
- Subscription to Rural Water Magazine
- and more!



**Be a part of something bigger.  
Become a member today.**

Visit [nrwa.org/members](http://nrwa.org/members) for more information and to join today!



203 W. Center Street  
P.O. Box 287  
Madison, SD 57042  
www.sdarws.com

# ATC 2023

South Dakota Association of Rural Water Systems  
**ANNUAL TECHNICAL CONFERENCE**

## *Holly Hoffman* 2023 ATC KEYNOTE SPEAKER



**SEE HOLLY LIVE!**  
TUESDAY, JAN. 10<sup>TH</sup>  
KEYNOTE: 1:00 PM  
BREAKOUT: 3:00 PM

### **NEW FOR 2023!**

The **AWARDS BANQUET** is now on Tuesday, January 10 @ 12:00 PM, followed by Keynote Holly Hoffman in Gallery A-B-C

**ULTIMATE METER CHALLENGE** - How fast can you assemble a working water meter? Fastest times win prizes! More info on page 19.

Thursday's **LEGISLATIVE OPEN FORUM** now includes a sit-down breakfast @ 8:00 AM

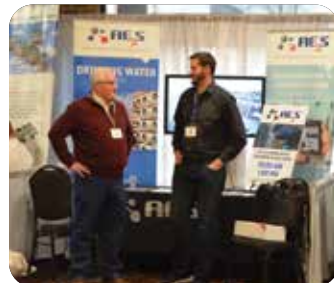

REGISTER ONLINE at [www.sdarws.com/atc](http://www.sdarws.com/atc)