

# ServiceLine

— The Official Publication of the South Dakota Association of Rural Water Systems —

## BLOWING SMOKE

## EXERCISING THE VALVES IN YOUR WATER SYSTEM

## \$1.2B PFAS SETTLEMENT

### 2024 ANNUAL TECHNICAL CONFERENCE

- CALL FOR PAPERS
- AWARDS SUBMISSION



# WHEN YOU NEED POWER, WE ARE THERE FOR YOU

NEW OR USED, ANY SIZE OR SHAPE, IN ANY REGULATORY ENVIRONMENT

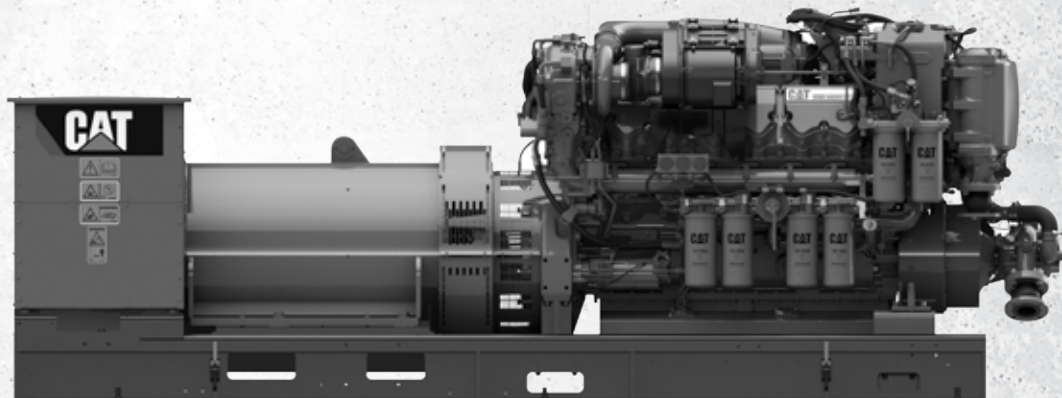

877.365.8114 | BUTLERMACHINERY.COM

Butler 



## QUALITY ENGINEERING SOLUTIONS FOR RURAL WATER PROJECTS

- MASTER PLANNING
- ASSET MANAGEMENT
- HYDRAULIC MODELING
- CAPACITY ANALYSIS
- STORAGE RESERVOIRS
- PUMPING STATIONS
- PIPELINES
- TREATMENT FACILITIES
- CONSTRUCTION SERVICES

MITCHELL, PIERRE, SIOUX FALLS, STURGIS  
SOUTH DAKOTA  
broszeng.com



**Brosz**  
ENGINEERING, INC.



# IN THIS ISSUE



- 5** Association Updates
- 7** Operator Certification Training Class  
And Exam Schedule
- 9** SDARWS Staff Directory
- 11** 2024 ATC Call for Papers
- 13** 2024 ATC Awards Nomination
- 17** 2023 Rural Water Open Recap
- 21** Rural Water Open Sponsors
- 23** Blowing Smoke
- 25** Exercising the Valves in Your Water System
- 27** Lead Serviceline Inventory
- 29** SDARWS Conferences And Events
- 31** Certification Questions
- 33** Photos From the Field
- 35** Nearly \$1.2B Settlement Win For Water  
Systems Against Manufacturers of PFAS

## SDARWS CORPORATE PARTNERS

Marsh & McLennan Agency, Inc.  
 Risk Administration Services  
 Dakota Pump & Control  
 Dakota Supply Group  
 Treatment Resources, Inc.  
 Banner Associates  
 Bartlett & West, Inc.  
 DGR Engineering  
 Maguire Iron, Inc.  
 Core and Main  
 Dakota Pump Inc.  
 CoBank  
 Milbank WinWater  
 AE<sub>2</sub>S  
 ISG  
 Brosz Engineering  
 Hawkins  
 Respec  
 Jetline Sales & Service

**Cover Photo: Lake time. Photo credit Jeff Fossum.**

ServiceLine is published bi-monthly by the South Dakota Association of Rural Water Systems. The contents of this publication may not be reproduced by any means, in whole or in part, without the prior written consent of SDARWS. SDARWS reserves the right to reject or edit any manuscripts received for publication. All submissions become the property of the South Dakota Association of Rural Water Systems unless otherwise specifically stated in this publication. Statements of fact and opinion are the responsibility of the authors alone and do not imply an opinion on the part of the South Dakota Association of Rural Water Systems. Advertisements and editorials do not represent official policies of the Association. Acceptance of advertising by SDARWS does not constitute endorsement of the advertiser, its products or services, nor does SDARWS make any claims or guarantees as to the accuracy or validity of advertisers' claims.

To submit editorial or advertising content, or to update your mailing information, please contact Jennifer Bame at 605-556-7219 or email [jbame@sdarws.com](mailto:jbame@sdarws.com).

**SOUTH DAKOTA ASSOCIATION OF RURAL WATER SYSTEMS**

P.O. Box 287, Madison, SD 57042 • Phone 605-556-7219, Fax 605-556-1497 • email: [info@sdarws.com](mailto:info@sdarws.com) • [www.sdarws.com](http://www.sdarws.com)  
Copyright 2023



## Engineering water solutions for community growth.

Clean, safe and reliable water is a basic building block of a modern community. Residents and industry depend on your system. You need proactive communications regarding system needs and innovative, comprehensive solutions. As a national leader with long-time relationships in water-focused services, Bartlett & West is your ally for success.

5900 S. Western Ave., Ste. 101 ■ Sioux Falls, SD  
(888) 200-6464 ■ [www.bartlettwest.com](http://www.bartlettwest.com)

# DAKOTA PUMP

### WATER PUMP STATIONS

- Modular Water Booster Stations
- Grade Mounted Water Booster Stations
- Water Booster Pump Stations
- Water Control Vaults

### WHY PREFABRICATED?

- Fully Factory Tested
- Ease of Installation
- Simplified Design
- Single Source Responsibility

### SEWAGE PUMP STATIONS

- Wet Well Mounted Lift Stations
- Flood Suction Lift Stations
- Self-Priming Lift Stations
- Obround Package Pump Stations

### PROACTIVE PUMP STATION SALES, MAINTENANCE AND INSPECTION

## WE PROVIDE SOLUTIONS BUILT ON RELATIONSHIPS

### DAKOTA PUMP OFFICES

#### MITCHELL

25524 413th Ave, Mitchell, SD 57301  
MAIN 605.996.6636 | CELL 605.770.9371

#### RAPID CITY

12065 Quaal Rd, #99, Black Hawk, SD 57718  
MAIN 605.996.6636 | CELL 605.430.2862

#### WATERTOWN (K&P PUMPS)

800 33rd St SW, Watertown, SD 57201  
MAIN 605.753.0072 | CELL 605.881.1586

PROACTIVE PUMP STATION SALES, MAINTENANCE AND INSPECTION | VISIT [DAKOTAPUMP.COM](http://DAKOTAPUMP.COM)



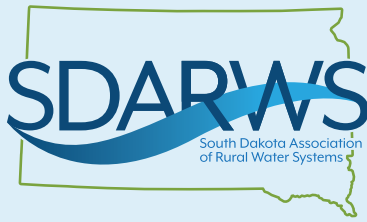

# ASSOCIATION UPDATES

## WATERPRO CONFERENCE



It's almost time for this year's WaterPro Conference at the Gaylord Rockies Resort & Convention Center in Aurora, Colorado, September 25-27, 2023 hosted by the National Rural Water Association.

NRWA puts on a fantastic show which brings in hundreds of vendors and hosts informative training sessions in operations, management, boardmanship and governance for those involved in water and wastewater utility systems – large and small, municipal and rural. WaterPro features expert speakers from across the water/wastewater industry. SDARWS is proud to be conducting not one, but two training sessions on Wednesday, September 27th at this year's WaterPro. SDARWS Marketing Coordinator Jennifer Bame will be presenting a session on Public Relations and Customer Engagement on Wednesday, September 27th at 9:45 AM in Crest 1&2. Her session is geared towards board members and will focus on why water systems need to tell their story, and how to increase customer engagement. Executive Director Kurt Pfeifle and Field Program Supervisor Jeremiah Corbin will also be leading a session on Wednesday titled, "Getting Results From Your Experts," at 1:30 PM in Crest 1&2. This session will cover how water system boards can best equip themselves to make decisions, and get the most from experts you work with, including engineers, contractors, etc. to make sure your board is getting their money's worth.

*The 2023 WaterPro Conference will feature presentations from SDARWS staff on Wednesday, September 27th.*



**Bame**



**Pfeifle**



**Corbin**

The WaterPro exhibit hall is filled with vendors and service-providers dedicated to offering high-quality solutions for small and rural water utilities. Find out about all the best solutions for rural water today and tomorrow. For more information on this conference, including registration and hotel reservations, please visit [waterproconference.org](http://waterproconference.org).

## 2023 TRAP SHOOT

SDARWS is gearing up to host our first ever Trap Shoot event on October 12th, 2023 at the Crooks Gun Club in Sioux Falls. It is a 2-person blind-draw, or pick your partner. Registration is \$100/person, or \$300 for a team, and includes shells and dinner. The event starts at 12:00 PM, with dinner being served at 5:00 PM. All shooters must be affiliated with SDARWS. For more information on this event, visit [sdarws.com/trap](http://sdarws.com/trap).



## LEADERSHIP SEMINAR

Association staff are prepping for our Annual Leadership Seminar which be held at the Best Western Ramkota Hotel in Pierre November 8-9, 2023. This seminar is geared towards Rural Water System Directors and Board Members, and includes informational sessions on water rates, asset management, sustainability, financing, and director and manager panels. The cost to attend Leadership is \$200, and includes a meal at the President's Reception on the evening of November 8th. Stay tuned for the agenda in the next issue of *ServiceLine*.



## ATC CALL FOR PAPERS

SDARWS is looking for presentations for our Annual Technical Conference in Pierre January 9-11, 2024. The ATC is our biggest training event of the year and hosts around 400 individuals. If your company is interested in hosting a training session, please submit your abstract by October 10th. For more information, please see page 11.

## ATC AWARD SUBMISSIONS

There are only a few more short months before the snow flies, so that means it's time to get in your award nominations for the ATC! Application and information can be found on pages 13-14. The deadline to submit applications is October 30th, and it can be done by mailing in the form on page 14, or online at [surveymonkey.com/r/ATCawards](http://surveymonkey.com/r/ATCawards).

# WATER TOWER EXPERTS



(605) 334-9749 | MAGUIREIRON.COM |    

EXTEND THE  
LIFE OF YOUR  
WATER TANK

## TANK MAINTENANCE & NEW TANKS

- Full-Service and Custom Tank Maintenance Plans
- Interior/Exterior Tank Painting
- Interior/Exterior Sandblasting and Containment
- Interior/Exterior Tank Inspections
- Lead Abatement
- Interior Tank Cleaning and Disinfection
- Custom Tank Logos
- Chemical Cleaning
- Tank Mixing Systems
- 24-Hour Emergency Services



MAGUIRE

**CHAD EDWARDS**

South Dakota Water Tower Expert  
(605) 759-4957 | edwardsc@maguireiron.com

## Your One Stop Shop for LCRR Compliance

Contact your state association to learn more about the partnership and available member discounts



Need help building your service line inventory? 120Water can help.



Looking for support with customer communications? We've got you covered.



Wondering how you're going to tackle school and daycare sampling? We'll manage it for you.



Head to  
[120water.com/water-utilities](https://120water.com/water-utilities)  
or scan the code to learn more.



120Water™



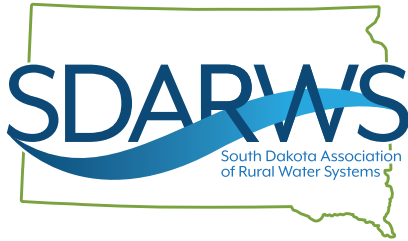

# OPERATOR CERTIFICATION TRAINING AND EXAMS

*Classes start at 8:00 AM Tuesday through Thursday. Classes end at approximately 4:30 PM on Tuesday and Wednesday, and noon on Thursday. One-day Workshops start at 8:00 AM and end at 4:30 PM.*

Course Name	Date	Location
Intermediate Water Treatment	August 29 - 31	Spearfish Holiday Inn
OpCert Exam	August 31 @ 1:00 PM	Spearfish Holiday Inn
Small Water Treatment Workshop	September 19	Via Zoom Only
Stabilization Pond Workshop	October 12	Huron - Huron Events Center
Stabilization Pond Workshop	October 17	Mitchell - Highland Conference Center
Wastewater Collection	October 24 - 26	Rapid City Ramkota - Rushmore Room
OpCert Exam	October 26 @ 1:00 PM	Rapid City Ramkota - Rushmore Room
Basic Wastewater Treatment	November 14 - 16	Spearfish Holiday Inn
OpCert Exam	November 16 @ 1:00 PM	Spearfish Holiday Inn
Water Distribution	December 5 - 7	Rapid City Ramkota - Rushmore Room
OpCert Exam	December 7 @ 1:00 PM	Rapid City Ramkota - Rushmore Room

**Register for training classes online at: [web.sdarws.com/events](http://web.sdarws.com/events)**

## EXAM INFORMATION

All exams cost \$60.00 and must be taken “in-person.”

Any exam can be taken at an exam session. You can take more than one exam at an exam session; however, the exam session remains at three hours long.

**All exam applications are due no later than two weeks prior to the exam date to DANR. Questions regarding exams can be directed to Tammie Hill with DANR at 605-773-3577.**

## DANR OPERATOR CERTIFICATION WEBSITE

[danr.sd.gov/OfficeOfWater/OperatorCert/default.aspx](http://danr.sd.gov/OfficeOfWater/OperatorCert/default.aspx)

*The Stabilization Pond class deals strictly with ponds/lagoons and is the best class for preparing to take the Small WW Exam. The Basic WW Treatment class deals with all types of wastewater treatment other than ponds/lagoons and is the best class for preparing to take the Class I WW Treatment exam. Small Systems that use ponds/lagoons for treatment can come into compliance with the Operator Certification Law by passing either the Small WW System exam or the Class I WW Treatment Exam.*

*Water systems serving less than 500 individuals and use wells as its source can come into compliance by passing the Small Water Treatment exam. Larger systems must pass the Class I Water Treatment exam or higher depending on the facility classification.*

## STUDY MATERIALS

DANR has water exam study material to lend to operators. These include manuals from California State:

- *Water Distribution System Operation and Maintenance*
- *Small Water System Operation and Maintenance*

## TRAINING CLASSES

Certification Training Classes are conducted by the South Dakota Association of Rural Water Systems. **These classes are presented at no charge.** Certified Operators can obtain contact hours for attending all of the above classes.

For more information on certification training classes, please contact Bill Thorson at 605-556-7219 (office) or 605-201-0170 (cell).

**For Study materials, visit: [www.abccert.org/testing\\_services/ExamReferences.asp](http://www.abccert.org/testing_services/ExamReferences.asp)**

# Winwater™

COMPANY

**S. Hwy. 15 • P.O. Box 350  
Milbank, SD 57252  
1-800-743-2972  
Fax 605-432-5447**

*Large enough to handle any job,  
but small enough to care about yours.*

- WATER PRODUCTS
- INDUSTRIAL PIPING
- WATER METER SYSTEMS
- PUMP SYSTEMS
- GEO TEXTILE FABRIC
- ROAD CASTINGS



engineering  
a better  
community

water | wastewater

Mni Wasté Water Supply Project | Cheyenne River Sioux Reservation | North Central SD

Brookings | Sioux Falls | Vermillion | Rapid City | Milbank  
605.692.6342 | Toll Free 1.855.323.6342  
[www.bannerassociates.com](http://www.bannerassociates.com)

**BANNER**  
engineering a better community



# SDARWS STAFF DIRECTORY



**KURT PFEIFLE**

*Executive Director*

kpfefle@sdarws.com  
605-204-0125



**MIKE MOELLER**

*Technical Assistance  
Training Specialist*

mmoeller@sdarws.com  
605-270-4989



**JEREMIAH CORBIN**

*Field Program Supervisor*

jcorbin@sdarws.com  
605-270-3894



**PAUL DORWART**

*Technical Assistance  
Training Specialist*

pdowart@sdarws.com  
605-201-9568



**ROBYN BROTHERS**

*Office Manager*

rbrothers@sdarws.com  
605-556-7219



**ALLEN KOCMICH**

*East River Circuit Rider*

akocmich@sdarws.com  
605-201-6026



**JENNIFER BAME**

*Communications &  
Marketing Coordinator*

jbame@sdarws.com  
605-556-7219



**GAVIN GRAVERSON**

*East River Circuit Rider*

ggraverson@sdarws.com  
605-501-2298



**STEVE ATTEMA**

*Safety Training  
Specialist*

sattema@sdarws.com  
605-270-1766



**WYATT HIX**

*West River Circuit Rider*

whix@sdarws.com  
605-641-4557



**BILL THORSON**

*Certification Training  
Specialist*

bthorson@sdarws.com  
605-201-0170



**DANNY AYERS**

*Wastewater Technician*

dayers@sdarws.com  
605-291-2299



**JEFF FOSSUM**

*Technical Assistance  
Training Specialist*

jfossum@sdarws.com  
605-201-9561



**KEVIN CHRISTENSON**

*Source Water Protection  
Specialist*

kchristenson@sdarws.com  
605-641-1923



# COMMITTED TO MAKING YOUR WORKPLACE SAFER

We're more than a workers' compensation insurance policy provider. We're your partner in driving injury prevention.

RAS has been the endorsed Work Comp carrier for the SD Rural Water Association for over 10 years.



**Our association agency partner:**

Justin Overman  
Marsh & McLennan Agency, LLC  
605.339.3874

RASCompanies.com  
800.732.1486



## Trusted. Professional. Solutions.

At DGR Engineering, we know about water and its vital role in everyday life. After all, we've been working in the industry since 1952. We provide our clients with solutions they can trust, covering all types of water services from supply, treatment, storage and distribution, to wastewater treatment, collection, and sewer rehab.

Call us today to discuss solutions for your next project.



Sioux Falls, SD  
Rock Rapids, Sioux City  
and Sioux Center, IA  
**800-446-2531**







## SOUTH DAKOTA RURAL WATER'S ANNUAL TECHNICAL CONFERENCE

# 2024 CALL FOR PAPERS

The South Dakota Association of Rural Water Systems is looking for presentations for our 2024 Annual Technical Conference in Pierre, SD January 9-11, 2024.

Please submit your abstract for SDARWS' 2023 ATC. Presentation themes may include, but are not limited to the following:

- Drinking water security strategies and tools
- How Water Storage Can Impact Water Quality
- Fair Labor Standards Act
- Hands-on sessions:
  - ◆ Control valve repair kits
  - ◆ Hydrant maintenance and repair
  - ◆ Solution pump repairs (diaphragm and peristaltic)
  - ◆ Repair couplers, saddles, wet tapping
- The importance of Cross Connection Control
- Water Rights for public systems
- Ice Pigging to clean water and sewer pipelines
- Source water protection and sustainability of water supplies
- Climate change, water and energy efficiency, and conservation
- Clean Water Act/SDWA connections, nutrient pollution, and Harmful Algal Blooms (HABs)
- Emerging drinking water treatment technologies and optimization of current technology
- State revolving loan fund tools and techniques/ green infrastructure strategies
- Small systems: TMF, sustainability strategies, technologies, and compliance
- Trench Safety
- Data management (e.g., SCADA, GIS, IT)
- Workforce, operator certification, and/or technical assistance initiatives
- Distribution system issues
- Emerging contaminants in drinking water, both chemical and microbial
- Drinking water research
- Sanitation and wastewater management
- Risk assessment, risk communication and consumer outreach
- Implementation of regulations – challenges and successes

If you would like to make a presentation, please submit a one-page abstract with the proposed presentation title, and the name, title, affiliation, and contact information for the speaker to:

**South Dakota Association of Rural Water Systems**  
PO Box 287  
Madison, SD 57042  
or email [ATC@sdarws.com](mailto:ATC@sdarws.com) by **October 10, 2023!**

**OR SUBMIT ONLINE AT**  
<https://tinyurl.com/ATCAbstracts>

### ALL SUBMISSIONS MUST COMPLY WITH THE FOLLOWING GUIDELINES:

1. Deadline for submissions is October 10, 2023
2. Abstract submissions are limited to text only.
3. The conference planning committee will select submitted abstracts for sessions.
4. Please include a five sentence biography along with a 500 word abstract or description of your presentation.

# Seeing success from your **PERSPECTIVE**

“We know your goals are bigger than just the project at hand. We’re invested in your overall best interest.”

*Dustin Dale, PE, AE2S Engineer*



Water Engineering and Beyond

*Award-Winning Best Place to Work*



Only the National Rural Water Association can bring together this unique Products and Services Portfolio.



That's the *Power* of Association.

[nrwa.org/members/products-services-portfolio/](http://nrwa.org/members/products-services-portfolio/)



# South Dakota Rural Water AWARD NOMINATIONS

Do you know someone who is doing a great job? Goes above and beyond the call of duty? Has your water system achieved excellence this year – or has overcome some amazing challenges?

**G**ive recognition where it is due by making an award nomination. Awards will be presented at the Awards Banquet. **Application deadline is October 30, 2023.** Eligible nominees must be affiliated with a system member in good standing. The online form can be found at [www.surveymonkey.com/r/ATCAwards](http://www.surveymonkey.com/r/ATCAwards).

WE ARE ACCEPTING NOMINATIONS FOR THE  
FOLLOWING CATEGORIES:

**Rural Water System of the Year:** Recognition for a member system who puts forth exceptional efforts to properly manage, operate, and maintain their drinking water system.

**Rural Water Manager of the Year:** Recognition for a manager of a Rural Water System for outstanding performance in operating a Rural Water System.

**Rural Water Office Person of the Year:** Recognition for an administrative employee of a Rural Water System for outstanding performance in office management and procedures.

**Rural Water System Operations Supervisor of the Year:** Recognition for a State of South Dakota Certified Operator who is actively working a supervisory role for a Rural Water System, and has demonstrated outstanding leadership ability and/or accomplishments in drinking water.

**Rural Water System Operations Specialist of the Year:** Recognition for a State of South Dakota Certified Operator who is actively working for a Rural Water System with outstanding leadership ability and/or accomplishments in drinking water.

**Municipal Water/Wastewater System of the Year:** Recognizes a municipality who puts forth exceptional efforts to properly manage, operate, and maintain their drinking water and wastewater system.

**Municipal Manager of the Year:** Recognition for a municipal manager for outstanding performance in managing a municipality.

**Municipal Office Person of the Year:** Recognition for an administrative employee of a municipality (i.e. clerk, finance officer, etc.) for outstanding performance in office management and procedures.

**Municipal Operations Specialist of the Year:** Recognition for a State of South Dakota Certified Operator who is actively working for a municipality with outstanding leadership ability/accomplishments in water.

**Spirit of Rural Water:** This award is presented to an individual, business or group that goes above and beyond for a rural water system or rural water cause. South Dakota Rural Water wants to recognize exceptional rural water advocates that stand out from the pack because of their commitment to rural water issues and/or their passion for the job. Eligible candidates include rural and community water consumers, employees, directors, as well as lawmakers, businesses, or any person or group that puts forth a noble effort to advance rural water.

**Donald B. Pospishil:** This award honors the work of Don Pospishil who dedicated many years of his life to helping small water systems across South Dakota. The Donald B. Pospishil Award is awarded to individuals who demonstrate leadership abilities in the water supply field, provide quality services to consumers, and exhibits professionalism and dedication while operating and maintaining a small water system.





# When It Comes To Waterworks, There Can Be A Lot Of Pressure.



To succeed, you need a partner that makes your job easier. With Dakota Supply Group, you get more than just pipe and products:

- ▶ Contact us today to learn more about how we can help you.



FARGO, ND ▶ [800] 342-4676  
 BISMARCK, ND ▶ [855] 337-9258  
 SIOUX FALLS, SD ▶ [800] 660-5531  
 RAPID CITY, SD ▶ [800] 660-5538  
 BURNSVILLE, MN ▶ [800] 325-0514

[www.dakotasupplygroup.com](http://www.dakotasupplygroup.com)

## Become a NRWA Supporting member today!

NRWA Supporting Members Receive:



For more information, contact Chance Winslett at [chance@nrwa.org](mailto:chance@nrwa.org) or 580-252-0629 or by visit [www.nrwa.org/members](http://www.nrwa.org/members)



# WATER TREATMENT'S TOTAL SOLUTION



- ✓ Best-in-Class Process-Pump-Flow Control Equipment
- ✓ Custom Chemical Feed Skids
- ✓ Local Service and Product Support
- ✓ Proudly Serving Municipal & Industrial Markets



[WWW.VESCO.COM](http://WWW.VESCO.COM)

952-941-2678

ISG



DRIVEN BY  
**PASSION+**  
**PURPOSE**

101 South Reid Street + Suite 202, Sioux Falls, SD 57103  
605.274.6401

Architecture + Engineering + Environmental + Planning | ISGInc.com



Join Our Team!  
[bit.ly/WW\\_WW\\_Jobs](https://bit.ly/WW_WW_Jobs)



## Expertise Snapshot

- Capital Improvement Plans
- Feasibility Studies
- Grants + Funding Support
- Hydraulic System Modeling + Analysis
- Industrial Wastewater
- Inflow + Infiltration Studies
- Master Planning + Facility Plans
- Permitting
- Sanitary Sewer + Wastewater Collection
- Site Selection + Surveying
- User Rate Studies
- Wastewater Treatment
- Water Reuse
- Water Treatment
- Water + Wastewater Operations





# SDARWS' 37<sup>TH</sup> ANNUAL RURAL WATER OPEN

We couldn't have asked for better weather for the 2023 Rural Water Open. 204 golfers on 51 teams filled the greens at Elmwood Golf Course in Sioux Falls for the annual tournament. Each golfer was treated to a cooler bag filled with golf goodies and drink tickets. As golfers arrived for their tee times, they were also treated to Flyboy coffee and donuts courtesy of Hawkins.

Teams were sent out on the East, North, and West Nine every seven to eight minutes starting at 8:30 AM. The last teams hit the course at 10:37 AM. The WaterPac challenges returned this year, with On-The-Green-In-One-Shot challenges on both #8 East and West. This year also brought back the Pick-Your-Club Putt challenge. Participants chose a random card which told them what kind of club they'd need to make a six-foot putt. The options included a hockey stick, leak detector, whiffle ball bat, kid's plastic putter, and more. For an extra \$10 they could use their own putter. Mulligans were also available through pre-sales and on the course. This year the Mulligans raised \$2,595 for WaterPac. The On-the-Green challenges raised \$2,340 and the putt challenge raised another \$790. All told, \$5,725 was raised for WaterPac, making this a record breaking WaterPac fundraiser for South Dakota Rural Water.

Following Rural Water Open traditions, this tournament format includes a four-person teams playing an 18-hole scramble with no championship or amateur division. As always, an array of

talent was on display. Scores were competitive this year with the majority of teams posting scores below par. Scores ranged from 15 under to 12 over. Due to the nature of the dynamic field, scoring was based on score under or over par based on the particular 18 holes a team played. Also, tiebreakers were decided by hole handicap and final rulings were determined by the club professional, Chad Veire. The top placing teams are listed on page 18.

Box lunches consisting of a beef tenderloin sandwich, potato salad, a bag of chips, and a cookie were made available to each participant as they passed the clubhouse as they made the turn for their second nine holes. Each golfer was also provided with a tournament cooler bag filled with a sleeve of balls sponsored by Hawkins, bug spray, ball cleaner, sunblock, and two drink tickets provided by AE2S. Prizes were sent out to winners after the conclusion of the event.

We would like to thank all the sponsors, participants, and volunteers who helped make this event successful. The full list of 2023 Rural Water Open Sponsors can be found on page 21.

Thanks also go out to the Corporate Partners that helped make this event possible – they are listed on page three. Without their support it would be impossible to provide this event at the level that competitors have come to enjoy. Stay tuned for information on our 2024 Rural Water Open. 💧

# 2023 RURAL WATER OPEN STANDINGS

## 1ST FLIGHT WINNERS

- 1st – Malloy Electric:** Todd Olmschenk, Sam Hinton, Thomas Hudson, Ryan Sauerer (57)  
**2nd – Individuals Unite:** Cory Ross, Farrell Anderson, Julia McCusker (59)  
**3rd – Marsh McLennan Agency:** Justin Overman, Clint Koehn, Jim Auen, Joe Munson (61\*)  
**4th – HR Green:** Mo Brua, Mark Hardie, Nick Borns, Andy Berg (61)  
**5th – #OneTeam:** Gavin Graverson, Greg Stahl, Kenny Hartzell, Jerry Adler (62\*)

## 2ND FLIGHT WINNERS

- 1st – Core and Main:** Tim Monson, Ben Aning, Jake Fitzgerald, Scott Neimeier, Kade Hansen (65\*)  
**2nd – Core and Main:** Chad Hanson, Dustin Sulzle, Alicia Petersen, Duane Walters (65\*)  
**3rd – Thein Well:** Zack Thein, Aaron Butler, Brent Hoffman, Joe Zauner (65\*)  
**4th – Clay #1:** Rob Ganschow, Andy Ganschow, Dan Rederick, Justin Polley (65\*)  
**5th – Sherwin Williams:** Casey Holter, Brian Cooper, Bill Sealey, Tyson Rosenboom (65\*)

## 3RD FLIGHT WINNERS

- 1st – Maguire 2:** Curt Hemmer, Dan Engelsman, Troy Werdel, Corey Sanders (69\*)  
**2nd – MCWC 2:** Tom VanWell, David Fox, Scott Vander Meulen, Taylor Fauth (69)  
**3rd – Brosz #2:** Corey Smith, James Buhman, Deryn Beck, Brad Lawrence (70)  
**4th – AE2S:** Brian Bergantine, Rod Kappes, Tore Raap, Denise Raap (71)  
**5th – SPN:** Jeff McCormick, Al Cerny, Bob Babcock, Mike Schmidt (72)

## LAST PLACE

- Last – RCWD 1:** Mason Wright, Grant Petrik, Corey DeBey, Trent Wright (84)

## FLAG PRIZE WINNERS

- Closest to the Pin #4:** Patrick Bunkers  
**Longest Drive #7:** Ryan Sauserer  
**Longest Putt #9:** Barry Berg  
**Closest to the Pin #12:** Joe Munson  
**Longest Drive #16:** Jerry Backes  
**Longest Putt #17:** Nolan Meyer  
**Closest to the Pin E5:** Weston Blasius  
**Longest Drive E7:** Lance Frogner  
**Longest Putt E9:** Justin Walsh

## CHALLENGE HOLE WINNERS

- On The Green (8W):** Blake Harm  
**On The Green (8E):** Rich Crow Eagle  
**Putt Challenge – 2 Putts In:** Jordan Bosch  
**Putt Challenge – 1 Putt In:** Troy Larson

## TEAM PRIZES

- 1st Place each flight:** \$500 Elmwood Gift Certificate  
**2nd Place each flight:** \$400 Elmwood Gift Certificate  
**3rd Place each flight:** \$300 Elmwood Gift Certificate  
**4th Place each flight:** \$200 Elmwood Gift Certificate  
**5th Place each flight:** \$100 Elmwood Gift Certificate  
**Last place:** Golf Lessons at Elmwood

\* denotes scorecard playoff









**NEVER TAKE RISKS  
WITH WHAT  
YOU'RE MADE OF**

Ford Meter Box will never compromise the quality of our brass products or alloy because communities around the world depend on them for reliable delivery of clean water. Ford's underground services endure for generations because of what they're made of.

**FORD**  
FORD METER BOX  
www.fordmeterbox.com  
260-563-3171

Play Video

**GNE**

**WATER**  
PROCESS EQUIPMENT

**WASTEWATER**  
PROCESS EQUIPMENT

**LOCAL SD**  
PARTS, SERVICE & SUPPORT

Great Northern Environmental  
**651.289.9100**  
www.gnenv.com | kfritze@gnenv.com

**STRUCTURE.  
& INTEGRITY.**

**PITTSBURG  
TANK & TOWER  
GROUP**  
An ESOP Company Since 1919  
"100 years and still climbing"

**CREWS  
AVAILABLE  
GLOBALLY**

**WWW.PTTG.COM**

INSPECTIONS	REPAIR	TANKS
Wet Dry ROV In-Service Cleaning	Code Updates Paint Insulation	Elevated Ground Relocation Erection Dismantles
<b>NEW TANKS</b> - Rick DiZinno (270) 826-9000 ext. 2601	<b>EXISTING TANKS</b> - Jordan Pyles (270) 826-9000 ext. 4601	

**JETLINE**  
SALES & SERVICE

Official Dealer & Distributor For

**rausch** USA

**SOUTHLAND  
TOOL MFG. INC.**

**USB-USA**

Chase Johnson 320.290.5764 | chase@jetlinesales.com | www.jetlinesales.com

# THANK YOU TO THIS YEAR'S RURAL WATER OPEN SPONSORS

## LUNCH SPONSOR



## GOLD TEE BOX SPONSORS



## BEVERAGE CART



## BRONZE TEE BOX SPONSORS



## BALL SPONSOR



## CART GPS SPONSOR



## KEG SPONSORS



## COFFEE & DONUTS







**ELECTRIC PUMP**



An Electric Pump Company



800-211-6432

[www.electricpump.com](http://www.electricpump.com)

115 Lipton Street  
Suite B  
Tea, SD 57064

402-333-9660

[www.mc2h2o.com](http://www.mc2h2o.com)

# SPN & ASSOCIATES

**ENGINEERS SURVEYORS GIS SERVICES**

Schmucker, Paul, Nohr and Associates

2100 N. Sanborn Blvd – PO Box 398  
Mitchell, SD 57301  
Phone (605) 996-7761  
FAX (605) 996-0015  
[www.spn-assoc.com](http://www.spn-assoc.com)

Water • Wastewater • Storm Water • Streets  
Airports • Solid Waste • Animal Waste  
Land Surveying • Site Development  
Geographic Information Systems (GIS)



**ENGINEERING EXCELLENCE  
SINCE 1961**

# BLOWING SMOKE

**Jeff Fossum, SDARWS Wastewater Technician**

Some may say that Jeff Fossum has been blowing smoke or something close to that for many years now! The next question that is most likely coming to your mind is, “What this old Circuit Rider doing writing about or thinking that he can add new insight to this infiltration tool?”

In my past life (my job in the municipal world), the late Jerry Hemeyer from South Dakota Rural Water brought his blower and a box resembling TNT sticks with a fuse in one end. Being a younger worker with a good imagination, I thought about some of the old western movies and tv shows where you would throw the lighted sticks of dynamite over at the bad guys! Occasionally, the stick would have a short or fast fuse that would blow up, killing or maiming the good guy (me). Of course, I was wearing a white cowboy hat in this scenario. Then Jerry brought me back to reality and informed me that the TNT sticks were no more than a giant smoke bomb that would last about three minutes. We checked the area for smoke saturation while the smoke circulated through the sewer or storm sewer. The test would move to the next target area if Jerry felt the coverage was good. Or if he felt different, he would light one more stick until satisfied. This was a fun job until smoke would enter somebody’s home through a dry drain or unglued plastic fitting. Jerry had often helped find the answer to sewer problems by blowing smoke. Once, our whole town was smoke tested to help find some big problems in the wastewater collection system. Another time Jerry came to our rescue was when an old, large public building had some smell and headache issues. After smoke testing the facility, it was found that the old cast iron soil pipe was cracked in multiple places. At a different time, an apartment house had a bad smell. The culprit was a floor drain hidden under the washing machine; it was a simple fix to add water to the drain.

I have gotten some field experience, and the equipment is about the same, but the smoke stick has been replaced by a gas-powered blower that uses the exhaust heat of its engine to heat a specialized liquid into a white harmless smoke. The best part of the machine that SDARWS owns is it is manufactured locally in Harrisburg, SD.

The number one problem in the field is cleanouts – either they are broken, or the cap is missing. One such place was in a flood zone. Can you imagine how much water can go down a pipe covered with a foot of water for how many days?

What I am trying to say with all of this is you never know when you will use the information taught to YOU today. A big shout out to my co-wastewater tech Danny Ayers; thank you for being such a great partner. Jerry Hemeyer, your knowledge and guidance is still being passed on from previous onsite smoke testing lessons.

If your city needs any wastewater assistance, please don’t hesitate to contact Danny or myself – we’d love to share our knowledge with you. 💧



**JEFF FOSSUM** joined the SDARWS staff in February 2018 after he retired as the Water/Wastewater Superintendent at the City of Canton, SD after 32 years. Jeff is certified in Class II Water Treatment, Class II Water Distribution, Class II Wastewater Treatment, and Class II Wastewater Collection. His interests include gardening, woodworking, and talking.





Become More. Do More. Experience More.



September 25-27, 2023

Gaylord Rockies Resort & Convention Center | Aurora, Colorado

Visit [waterproconference.org](http://waterproconference.org) for more information.



The Official Conference of National Rural Water Association



# Your number one source

Top providers of creative water and wastewater solutions with over 75 years of combined experience.



[treatmentresources.com](http://treatmentresources.com) • 612 702-2692



# EXERCISING THE VALVES IN YOUR WATER SYSTEM



## Mike Moeller, SDARWS Training Specialist

One of the most important things an operator of a water system must have is control of that system. The valves in the system are an integral part of that control. When an operator has to isolate part of the system for any reason, if the valves they are using don't close fully or turn very hard, it makes for a long day for that operator.

Valve exercising is a preventative maintenance step that can be done periodically to help eliminate problem valves in your system. Exercising the valves ensures the proper function of the valve, and if flushing is done while exercising, it will also pull debris from the seat area of the valve so that the valve can close fully when needed.

South Dakota Association of Rural Water Systems has recently purchased a second valve exerciser. We will have one at our east river office and one at our west river office. SDARWS recommends that you exercise your valves every couple of years. Some of the systems that I have performed valve exercising at have waited longer than a couple of years, and when it came time to exercise them, many of the valves turned very hard. If it had been a severe situation where the valves needed to be turned quickly, they wouldn't have been able to do it.

Another part of the valve maintenance equation is ensuring the valve risers are clean. SDARWS has a hydro-vac at each office and can clean all the debris from the valve risers before exercising them. When a system calls us to exercise valves, we often have to make multiple trips because we find that the valve risers are full of debris and you can't get the valve wrench on the nut to operate the valve. We then have to get our hydro-

vac and clean them before we can exercise them.

If you haven't exercised your system valves in quite some time (or ever), don't be afraid to give SDARWS a call at 605-556-7219 and ask us bring our equipment to assist.



**MIKE MOELLER** has worked for SDARWS since 2014. He previously worked at Dakota Pump and Control for five years, and served 30 years with the South Dakota National Guard. Mike also holds an Advanced Safety Certificate from the National Safety Council.



# Water Treatment Chemicals, Equipment and Local Service

Scan this QR code  
to see the Hawkins  
testimonial video.



800.328.5460  
wtg@hawkinsinc.com

Black Hawk, SD 605.787.6881    Sioux Falls, SD 605.368.5793    Fargo, ND 701.293.9618    Washburn, ND 701.462.8588

*Customized solutions by a  
professionally trained team.*

### SERVICE

- Mini Bulk Delivery
- Equipment Installations
- Laboratory Testing

### WATER TREATMENT

- Potable Water
- Wastewater Treatment
- Collection Systems

### EQUIPMENT

- Chemical Injection Pumps
- Chlorination Control
- Chemical Feed Equipment

## Now Hiring for Sales & Service!

Visit [www.hawkinsinc.com/careers](http://www.hawkinsinc.com/careers) for current openings and locations



Since 1913, HR Green has provided solutions that build communities and improve lives.



▶ SIOUX FALLS

▶ [HRGREEN.COM](http://HRGREEN.COM)

# Lead Service Line Inventory

What you (and your customers) need to know

To encourage your customers to complete the lead service line inventory, you'll need to understand the project and how to communicate about it. Luckily, there are messaging and communication tools already available for you.

## Lead Service Line Requirements

The more "unknown" service lines you have, the more you'll have to replace, according to the Lead and Copper Rule.

Systems with lead service lines with compliance sampling results over **15 micrograms/liter** after corrosion control treatment installation must replace **7%** or more of the lead service lines in their distribution system per year—including lines marked as "unknown."



## Spread the word to complete the survey

Visit [sdwaterpipes.com](https://sdwaterpipes.com) to learn more about the project and access important resources to help with your customer communication.

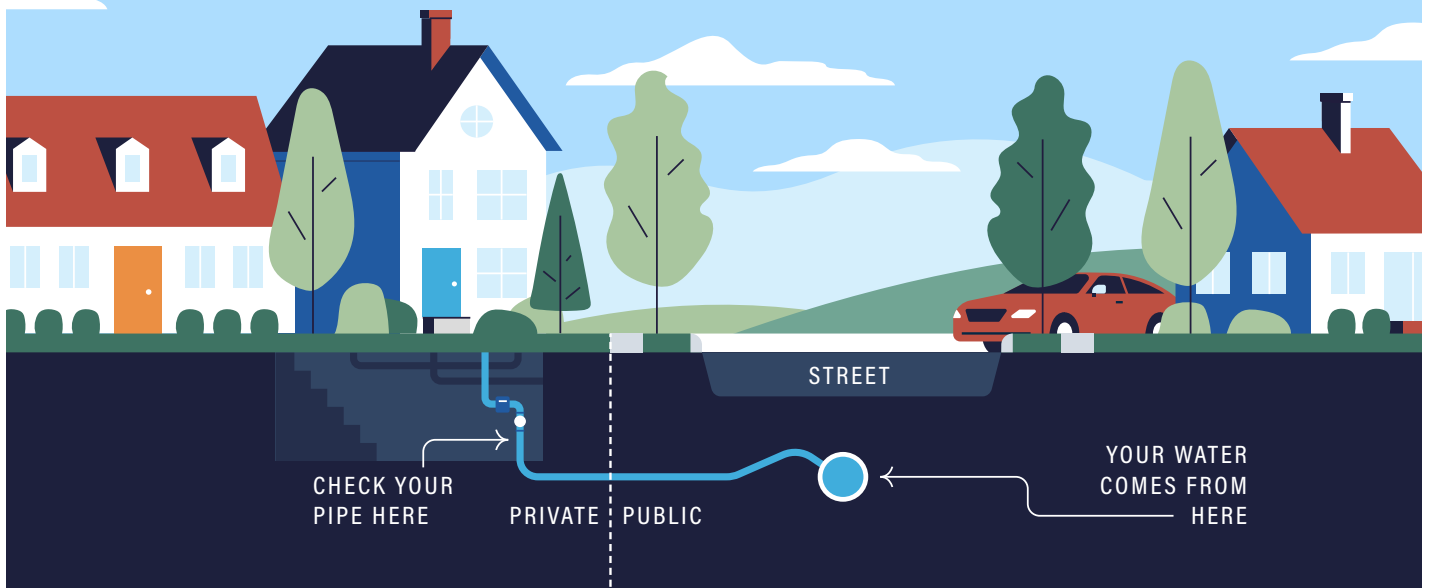



## Initial inventory deadline: October 16, 2024

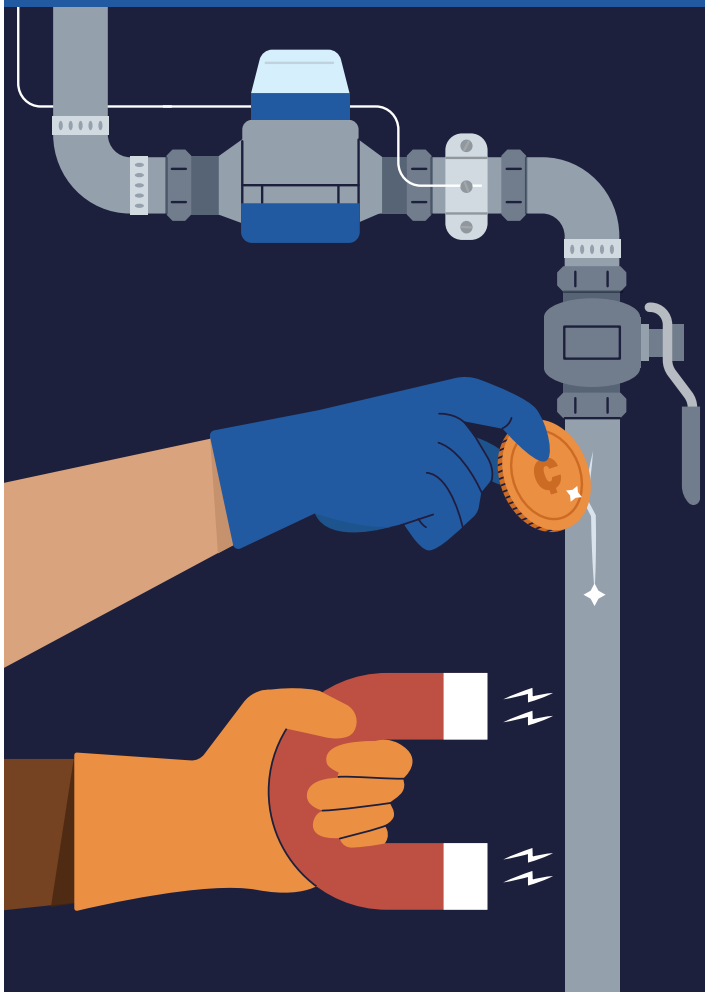

### Requirements after the deadline: EPA

- Update every year or every three years based on the lead tap sampling frequency
- Systems that demonstrated absence of lead service lines by October 16, 2024, don't need to provide an update

### Requirements after the deadline: Customer follow-up

Provide notification to the persons served at the water connection with a LSL, GRR, or "lead status unknown" service line

- 30 days after completing the initial inventory; repeated annually until only non-lead service lines remain
- At time-of-service installation for new customers

### Here are some suggestions you can consider communicating with your customers:

#### Your customer's service line has been identified to contain lead. What now?

- 1 We will be noting it in our inventory and designating it to be replaced in the near future.
- 2 In the interim, because your line has lead, you can flush your line. Use a NSF/ANSI 53 certified pitcher filter to protect yourself until the line is replaced.
- 3 Consider offering to collect a water quality sample from their service.

Visit [sdwaterpipes.com](https://sdwaterpipes.com) to learn more, access resources for the project, and start sharing information with your customers.

# SDARWS Conferences & Events



## Trap Shoot | October 12, 2023

The First Annual Rural Water Trap Shoot takes place in at the Crooks Gun Club. This tournament is open to Utility Members, Associate Members, and Corporate Partners of SDARWS. Registration is \$100/player or \$150 to pick your partner. Includes shells and dinner. **For more information, visit [sdarws.com/trap](https://sdarws.com/trap) or email [ggraverson@sdarws.com](mailto:ggraverson@sdarws.com)**



## Leadership Seminar | November 8-9, 2023

This seminar is geared towards Rural Water System Directors and covers a gamut of topics pertaining to rural water boards and system leadership.

**For more information, visit [sdarws.com/leadership](https://sdarws.com/leadership) or email [jcorbin@sdarws.com](mailto:jcorbin@sdarws.com)**

**Pierre Ramkota Hotel & Convention Center  
920 W. Sioux Ave. • Pierre, SD • 605-224-6877**



## Annual Technical Conference | January 9-11, 2024

The ATC is the annual conference of the South Dakota Association of Rural Water Systems, and is the largest water/wastewater conference in South Dakota. This event is designed to bring together water and wastewater utility systems – both large and small, municipal and rural – for sessions in operations, management, boardsmanship and governance. This conference is held every year during the first week of the South Dakota Legislative session in Pierre, SD and hosts over 500 attendees.

**To learn more, visit [sdarws.com/ATC](https://sdarws.com/ATC) or email [atc@sdarws.com](mailto:atc@sdarws.com)**

**Pierre Ramkota Hotel & Convention Center  
920 W Sioux Ave. • Pierre, SD • 605-224-6877**



## Rural Water EXPO | April 24-25, 2024

The EXPO is open to all water and wastewater utility staff, board/council members, engineers, State and Federal employees. The training will consist of 13 presentations, 30 minutes each, thus allocating ten contact hours for those individuals who are licensed operations specialists. Along with the training sessions, the EXPO will showcase many of our industry's manufacturer and supplier leaders. Many will be displaying the recent advances in technology our industry has witnessed over the past several years.

**To learn more, visit [sdarws.com/EXPO](https://sdarws.com/EXPO) or email [expo@sdarws.com](mailto:expo@sdarws.com)**

**Rapid City Ramkota Hotel & Convention Center  
2111 N Lacrosse Street • Rapid City, SD • 605-343-8550**



## Rural Water Fishing Tourney | April 2024

The Annual Rural Water Warriors Fishing Tournament takes place at the Outpost Lodge on Cow Creek Bay in 2024. Teams consist of 2-3 people with at least one person who is a current water/wastewater, associate member or corporate partner of the SDARWS. This tournament is limited to 40 teams. There is an eight fish maximum per boat with the largest seven fish weighed, and all South Dakota fishing regulations must be followed. A mandatory rules meeting is held at 8:00pm the night before the tournament.

**For more information, visit [sdarws.com/fishing](https://sdarws.com/fishing) or email [fishing@sdarws.com](mailto:fishing@sdarws.com)**

**Outpost Lodge on Cow Creek Bay  
Cow Creek Recreational Area, 28229 Cow Creek Rd. • Pierre, SD • 605-264-5450**



## Rural Water Open Golf Tourney | July 2024

The Annual Rural Water Open will take place in Sioux Falls. This tournament is open to Utility Members, Associate Members, and Corporate Partners of SDARWS. Registration is \$100/player and includes golf, cart, lunch, and awards.

**For more information, visit [sdarws.com/golf](https://sdarws.com/golf) or email [golf@sdarws.com](mailto:golf@sdarws.com)**



**Bridging the gap**  
between idea +  
achievement

Sioux Falls 605.977.7740  
Rapid City 605.791.6100  
[hdrinc.com](http://hdrinc.com)



## Special Loan Terms for SDARWS Members!

**South Dakota Association of Rural Water Systems (SDARWS) has partnered with CoBank,**

a national cooperative bank that serves rural America, to provide attractive financing solutions for SDARWS members. Find out about the specially negotiated terms on many loan products and bonds for water and wastewater utilities, including:



- ✓ USDA INTERIM CONSTRUCTION FINANCING
- ✓ USDA GUARANTEED LOANS AND BONDS
- ✓ LINES OF CREDIT
- ✓ DEBT REFINANCING
- ✓ TERM FINANCING



**CONTACT**  
**Michael Griffiths**  
**Call: 720-520-6261**  
**Email: [griffiths@cobank.com](mailto:griffiths@cobank.com)**





# CERTIFICATION PRACTICE QUESTIONS

1. **Turbidity in wastewater is caused by**
  - a. color.
  - b. dissolved calcium.
  - c. hardness.
  - d. finely divided suspended material.
2. **The gas most commonly associated with septic wastewater is**
  - a. carbon dioxide.
  - b. carbon monoxide.
  - c. hydrogen sulfide.
  - d. methane.
3. **How many cubic meters per second in 10 MGD?**
  - a. 0.44
  - b. 1.44
  - c. 4.73
  - d. 24.62
4. **An upright circular cylinder tank (flat bottom) has a diameter of 12 feet. When filled to a depth of 8 feet, the volume is**
  - a. 226.2 cubic feet.
  - b. 904.8 cubic feet.
  - c. 3619 cubic feet.
  - d. 5000 cubic feet.
5. **Mechanical ventilation of a lift station is required to**
  - a. lower temperatures to reduce proportion of hydrogen sulfide.
  - b. reduce chlorine demand.
  - c. reduce corrosion.
  - d. increase DO in raw wastewater.
6. **A wet well probe is usually used for \_\_\_\_\_ determination(s) of level.**
  - a. approximate
  - b. dual point
  - c. continuous
  - d. single point
7. **A pump is delivering at less than the expected rate of discharge. Which of the causes listed below is incorrect?**
  - a. speed of motor too low.
  - b. pump not primed.
  - c. impeller clogged.
  - d. discharge head too low.
8. **Metal pipes often fail because of**
  - a. back siphonage.
  - b. browning movement.
  - c. galvanic action.
  - d. reverse osmosis.
9. **A centrifugal pump is pumping 200 gpm against a 40-foot total pumping head. The output power of the pump is about \_\_\_\_\_ horsepower.**
  - a. 0.5
  - b. 2
  - c. 15
  - d. 121
10. **When a fire hydrant is operated, it should be**
  - a. just opened enough to have a flow.
  - b. opened fully.
  - c. opened halfway.
  - d. regulated to flow required.

# RESHAPING THE FUTURE OF UTILITY TECHNOLOGY



Analytics



Security



Mobility



Office



Field

## An Integrated Technology Cooperative.

CSA/PCS is an industry leader in utility software solutions. As a member-owned cooperative, we strive to provide best-in-class integrated solutions for: billing, financials, engineering, operations, analytics, and customer empowerment - in a secure, hosted environment.

*We provide a true enterprise experience.*

888-843-3106 • pcs-csa.com



Central Service Association

Professional Computer Solutions



The Leading Distributor of Water, Sewer & Storm Drain Products & Services



**WE'RE ALL ABOUT**

*South Dakota*

When you need dependable service in the middle of the night, the eye of the storm or the center of town, you need the waterworks experts at Core & Main.

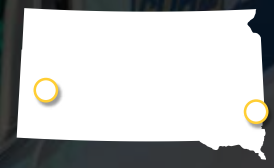

**Sioux Falls**

2101 E 54th St N  
(605) 339-2814

**Rapid City**

2808 E Highway 44  
(605) 716-9427

**FUSIBLE PIPING**

**METERING AMR/AMI**

**TREATMENT PLANTS**

**STORM DRAIN**

**PUMPING**

Local Knowledge | Local Experience | Local Service, Nationwide®

**coreandmain.com**

PASD20190529



# PHOTOS FROM THE FIELD

*Some of our SDARWS Staff traveled to Ft. Lauderdale, Florida to attend NRWA InService Training this past June. Below are a few highlights from the trip.*



*Training Specialist Bill Thorson going over Safe Water Drinking Water Act Rules with Connor Penfield from Dakota Dunes.*



*Kevin Christenson presents a source water protection program to children attending the Farmer's Union Environmental Camp in Kimball, SD*



*SDARWS Wastewater Tech Danny Ayers readying the "Clingy Dinghy" for a lagoon voyage in Beresford, SD.*

# USDA WATER & WASTE WATER DISPOSAL LOAN AND GRANT PROGRAM

Improve Your Facility

## About the Program

This program provides funding for clean and reliable drinking water systems, sanitary sewage disposal, sanitary solid waste disposal, and storm water drainage to households and businesses in eligible rural areas.

## Funding

Long-term, low-interest loan funding is available. If funds are available, a grant may be combined with a loan if necessary to keep user costs reasonable.

## USE YOUR FUNDS TO FINANCE THE ACQUISITION, CONSTRUCTION, OR IMPROVEMENT OF:

- 01 Drinking water sourcing, treatment, storage, and distribution
- 02 Sewer collection, transmission, treatment, and disposal
- 03 Solid waste collection, disposal, and closure
- 04 Storm water collection, transmission, and disposal
- 05 Other related activities such as permits and legal fees



Scan the QR code to view more information and start your application.





# FROM THE EXECUTIVE DIRECTOR

KURT PFEIFLE, EXECUTIVE DIRECTOR

## NEARLY \$1.2B SETTLEMENT WIN FOR WATER SYSTEMS AGAINST MANUFACTURERS OF PFAS

The National Rural Water Association (NRWA) is thrilled to announce a \$1.185B settlement has been reached in litigation against the manufacturers of perfluorooctanoic acid and perfluorooctane sulfonate (“PFAS”), including DuPont, Chemours, and Corteva. Napoli Shkolnik Law Firm, NRWA’s official partner, was a key player in the settlement that was announced earlier, which will help water systems affected by PFAS.

“We applaud the court, the leadership of Paul Napoli, and the work of the Napoli Shkolnik Law Firm for recognizing the need for these companies to be held accountable,” said John O’Connell, NRWA Board President. “This settlement is the beginning of helping our utility members in the fight against PFAS. We recognize there is still much work ahead to remove PFAS from rural areas.”

While a settlement has been reached between these companies, the trial against the remaining defendants, including 3M, is set for June 5, 2023, in Charleston, South Carolina.

NRWA has created the PFAS Cost Recovery Program to help systems with PFAS treatment costs. If your system has already signed up for the program, Napoli will be in contact with you with next steps, which may involve more testing. If your system has not registered for the program, we encourage you to contact Napoli Shkolnik PLLC to represent your system as a trusted attorney who will fight for compensation to overcome the financial impacts of PFAS. NRWA has retained the firm to represent the Association and our members.

### NRWA LEADERSHIP AND LITIGATION

NRWA’s leadership had the foresight to see and understand that PFAS, including the monitoring of levels, treatment, and remediation costs, would be a major issue for rural water and wastewater utilities. Early in 2018, NRWA partnered with Napoli Shkolnik PLLC to file a lawsuit on behalf of its members.

“It is great to see the board’s vision start to come to fruition,” said Matthew Holmes, NRWA Chief Executive Officer. “We hope this settlement will benefit our members and rural systems across the country for many years to come as they continue to test and treat PFAS in our nation’s drinking water.”

### CONCLUSION

NRWA and its 50 State Rural Water Associations have been representing the needs and concerns of small and rural utilities as we navigate the challenges created by PFAS. NRWA acknowledges that Water Professionals are the backbone of

small and rural communities, providing safe drinking water and clean wastewater treatment while supporting economic growth and protecting public health.

While the details and next steps regarding the settlement have not been released yet, Rural Water will continue to provide solutions and advocate for you. NRWA strongly encourages water systems to contact Napoli Shkolnik PLLC online at [www.napolilaw.com/nrwa-pfas](http://www.napolilaw.com/nrwa-pfas) today to sign up for the PFAS Cost Recovery Program. This is just the first of many announcements to come regarding PFAS settlements and cost recovery options. NRWA and SDARWS will keep you updated with the latest information.

If your system has not registered for the program, we encourage you to contact Napoli Shkolnik PLLC to represent your system as a trusted attorney who will fight for compensation to overcome the financial impacts of PFAS.



203 W. Center Street  
P.O. Box 287  
Madison, SD 57042  
[www.sdarws.com](http://www.sdarws.com)

## PRIZES

Top Team - \$500  
Top Shooter - \$300



REGISTER  
ONLINE

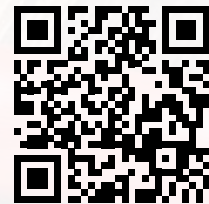

[sdarws.com/trap](http://sdarws.com/trap)

# OCTOBER 12, 2023

**Crooks Gun Club • 2808 259th Street, Sioux Falls, SD**

**Shooting starts @ 12:00 PM**

**Dinner @ 5:00 PM**

*All shooters must be affiliated with SDARWS*

\$100/per person\* (blind draw) or  
\$150/per person\* (pick your partner)

*\*Registration fee includes dinner and shells*

**South Dakota GF&P Crazy Quail Target Machine will be on hand as an added activity – make sure to bring some extra shells!**

*For more information on this event, please contact Gavin Graverson (605-501-2298) or Kevin Christensen (605-641-1923), or visit [sdarws.com/trap](http://sdarws.com/trap)*