

ServiceLine

The Official Publication of the South Dakota Association of Rural Water Systems

**LAGOON
TRAINING
CLASSES
SCHEDULED**

**WHO CARES ABOUT
MONEY?**

**LEADERSHIP
SEMINAR**
November 17-18, 2021

**TIME,
TALENTS,
TREASURES**

**THE COST
OF DOING
BUSINESS**

**35TH ANNUAL
RURAL WATER
OPEN RECAP**



Reimagine your
water solutions.

Evolved.

When you are using water, you don't usually think about where it comes from. That's how it should be. Smart management of a precious resource. It's second nature at KLJ.

KLJENG.COM



ENGINEERING, REIMAGINED



IN THIS ISSUE



SDARWS CORPORATE PARTNERS

Marsh & McLennan Agency, Inc.
 Risk Administration Services
 Dakota Pump & Control
 Dakota Supply Group
 Treatment Resources, Inc.
 Banner Associates
 Bartlett & West, Inc.
 DGR Engineering
 Maguire Iron, Inc.
 Core and Main
 Dakota Pump Inc.
 CoBank
 Milbank WinWater
 AE₂S
 ISG
 Brosz Engineering

- 5** From the SDARWS President
- 6** Lagoon Optimization Workshop Classes
- 7** Operator Certification Training Class and Exam Schedule
- 9** SDARWS Staff Directory
- 11** SDARWS Conferences & Events
- 13** 2022 ATC Call for Papers
- 14** ATC Award Nominations
- 16** 35th Rural Water Open Recap
- 21** The Cost of Doing Business
- 23** Time, Talents, Treasurers
- 25** Who Cares About Money?
- 29** Certification Questions
- 31** Onida Man Chosen To Head USDA Rural Development Community Programs In SD
- 33** Photos From the Field
- 34** From the Executive Director

Cover Photo: Water tower in Colman, SD. **Photo Credit:** Jeff Fossum

ServiceLine is published bi-monthly by the South Dakota Association of Rural Water Systems. The contents of this publication may not be reproduced by any means, in whole or in part, without the prior written consent of SDARWS. SDARWS reserves the right to reject or edit any manuscripts received for publication. All submissions become the property of the South Dakota Association of Rural Water Systems unless otherwise specifically stated in this publication. Statements of fact and opinion are the responsibility of the authors alone and do not imply an opinion on the part of the South Dakota Association of Rural Water Systems. Advertisements and editorials do not represent official policies of the Association. Acceptance of advertising by SDARWS does not constitute endorsement of the advertiser, its products or services, nor does SDARWS make any claims or guarantees as to the accuracy or validity of advertisers' claims.

To submit editorial or advertising content, or to update your mailing information, please contact Jennifer Bame at 605-556-7219 or email jbame@sdarws.com.

SOUTH DAKOTA ASSOCIATION OF RURAL WATER SYSTEMS
 P.O. Box 287, Madison, SD 57042 • Phone 605-556-7219, Fax 605.556.1497 • email: info@sdarws.com • www.sdarws.com
 Copyright 2021



**QUALITY
ENGINEERING
SOLUTIONS FOR
RURAL WATER
PROJECTS**

- MASTER PLANNING
- ASSET MANAGEMENT
- HYDRAULIC MODELING
- CAPACITY ANALYSIS
- STORAGE RESERVOIRS
- PUMPING STATIONS
- PIPELINES
- TREATMENT FACILITIES
- CONSTRUCTION SERVICES

MITCHELL, PIERRE, SIOUX FALLS, STURGIS
SOUTH DAKOTA
broszeng.com



MILBANK
WinwaterTM
COMPANY

S. Hwy. 15 • P.O. Box 350
Milbank, SD 57252
1-800-743-2972
Fax 605-432-5447

- WATER PRODUCTS
- INDUSTRIAL PIPING
- WATER METER SYSTEMS
- PUMP SYSTEMS
- GEO TEXTILE FABRIC
- ROAD CASTINGS

*Large enough to handle any job,
but small enough to care about yours.*



FROM THE SDARWS PRESIDENT

RON GILLEN, SDARWS PRESIDENT

WATER PRO CONFERENCE

It's almost time for the WaterPro Conference in Milwaukee, Wisconsin September 13-16, 2021. NRWA puts on a fantastic show which brings in hundreds of vendors and hosts informative training sessions in operations, management, boardsmanship and governance for those involved in water and wastewater utility systems – large and small, municipal and rural. WaterPro features expert speakers from across the water/wastewater industry. Want to hear about new USDA projects or EPA priorities? You can find out at the WaterPro Conference. The WaterPro exhibit hall is filled with vendors and service-providers dedicated to offering high-quality solutions for small and rural water utilities. Find out about all the best solutions for rural water today and tomorrow. For more information on this conference, including registration and hotel reservations, please visit waterproconference.org.

LEADERSHIP SEMINAR

Association staff are prepping for our Annual Leadership Seminar which be held at the Best Western Ramkota Hotel in Pierre November 17-18, 2021. This seminar is geared towards Rural Water System Directors and Board Members, and includes informational sessions on water rates, asset management, sustainability, financing, and director and

manager panels. The cost to attend Leadership is \$175, and includes a meal at the President's Reception on the evening of November 18. Registration for this event is available online at <https://tinyurl.com/SDLeadership>, or by calling the SDARWS office at 605-556-7219. Stay tuned for the agenda in the next issue of ServiceLine.

ATC CALL FOR PAPERS

SDARWS is looking for presentations for our Annual Technical Conference in Pierre January 11-13, 2022. The ATC is our biggest training event of the year and hosts around 400 individuals. If your company is interested in hosting a training session, please submit your abstract online at: <https://tinyurl.com/ATCAbstracts>. For more information, please see page 13.

ATC AWARD SUBMISSIONS

There are only a few more short months before the snow flies, so that means it's time to get in your award nominations for the ATC! Application and information can be found on pages 14-15. The deadline to submit applications is October 29th, and it can be done by mailing in the form on page 15, or online at www.surveymonkey.com/r/ATCAwards. If you have questions about the awards, please give the SDARWS Madison office a call at 605-556-7219. ♦



September 13-16, 2021
Wisconsin Center | Milwaukee, WI

The Conference for Water & Wastewater
Utility Systems
Large & Small, Municipal & Rural

Visit waterproconference.org for more information.



SDARWS HOSTING LAGOON OPTIMIZATION WORKSHOPS

August 25th, 2021: Webster, SD
August 26th, 2021: Eagle Butte, SD
September 22nd, 2021: Chamberlain, SD
September 23rd, 2021: Colman, SD

REGISTER ONLINE: sdarws.com/certification.html

There is no cost to attend this training. Six credit hours will be awarded. For more information, contact Steve Attema at sattema@sdarws.com or call 605-270-1766.

AGENDA

- 9:00 am** Introductions, Review Content and Agenda
- 9:05 am** The use of bio-augmentation in your collection system and stabilization ponds
- 10:30 am** Sludge judging lagoons – what, where and why
- 11:30 am** Working Lunch – Lagoon Troubleshooting / Discussion
- 12:30 pm** What to look for in engineering plans – operator perspective
- 1:45 pm** What to expect in a sanitary survey
- 3:00 pm** Adjourn

MARK YOUR CALENDAR

OPERATIONS SUPERVISOR FALL CONFERENCE



October 7-8, 2021
Cambria Hotel
Rapid City

For more information, contact Greg Gross at ggross@sdarws.com or 605-201-6026.

WATER TOWER EXPERTS



(605) 334-9749 | MAGUIREIRON.COM | [f](#) [t](#) [@](#) [in](#)

EXTEND THE LIFE OF YOUR WATER TANK

TANK MAINTENANCE & NEW TANKS

- Full-Service and Custom Tank Maintenance Plans
- Interior/Exterior Tank Painting
- Interior/Exterior Sandblasting and Containment
- Interior/Exterior Tank Inspections
- Lead Abatement
- Interior Tank Cleaning and Disinfection
- Custom Tank Logos
- Chemical Cleaning
- Tank Mixing Systems
- 24-Hour Emergency Services



CHAD EDWARDS

South Dakota Water Tower Expert
(605) 759-4957 | edwardsc@maguireiron.com





OPERATOR CERTIFICATION TRAINING AND EXAMS

IN-PERSON CLASSES HAVE RESUMED

Pre-Registration is required and will be limited based on the chart below. Those who have not pre-registered will not be able to attend in person training since we have a hard limit as to the number of tables and chairs that are being setup for the room size. During the registration process the operator will be able to choose if they wish to attend in person or online. Once the in-person limit has been reached any additional registrants will be for the online course. Those who either selected online training or were moved to online training will receive information on how to register for the online course through

Zoom and a link to download the course materials. All class times will take place in the time zone of the in-person class.

Vaccination rates and the course of the COVID-19 pandemic will determine when we can relax our social distancing requirements. If vaccination rates are high and the rate of new cases is low it may be possible to increase the number of people we can accommodate for in person training. Those operators who have pre-registered and were moved to online training will be notified in the event we can increase the number of in person attendees.

Course	Date	Location	In-Person Limit
Basic Water Treatment	August 17-19, 2021	Huron: Events Center	30 Registration Limit
Intermediate Water Treatment	September 28-30, 2021	Rapid City: Ramkota Sylvan Room	40 Registration Limit
OpCert Exam	September 30, 2021	Rapid City: Ramkota Sylvan Room	40 Seats Left
Stabilization Pond Workshop	October 10, 2021	Aberdeen: Ramkota Arikara Room	20 Registration Limit
Stabilization Pond Workshop	October 14, 2021	Mitchell: Highland Conference Center	20 Registration Limit
Water Distribution	November 16-18, 2021	Spearfish: Holiday Inn 76/Swarm Room	40 Registration Limit
Wastewater Collection	December 7-9, 2021	Sioux Falls: Ramkota Harvest Room	40 Registration Limit

Classes start at 8:00 AM Tuesday through Thursday. Classes end at approximately 4:30 PM on Tuesday and Wednesday, and noon on Thursday. One-day Workshops start at 8:30 AM and end at 4:30 PM.

TO ALL WATER/WASTEWATER SYSTEMS/ OPERATORS: Since 1970, DANR has been charging \$10 or less to take an Operator Certification Exam. The annual charge to renew a certificate has been \$6 or less. Obviously costs have increased since the 70's and DANR has been taking a significant loss every time a certification exam has been taken. The costs for an exam include the cost to have the exam corrected, exam room rental, per diem, and mileage.

SB 53 was proposed by DANR to allow us to charge what the actual cost of each exam is which is approximately \$60. The bill also eliminated the annual renewal fee. SB53 passed both houses of the Legislature and was signed by the Governor on February 24, 2021. The effect is that any OpCert exam taken after July 1, 2021 will cost \$60. With the renewal fee being eliminated, all operators that

have the proper number of contact hours and are still working in the water/wastewater field will have their certificates renewed automatically by DANR on July 1, 2021 and every February 1 after that. The operator does not have to do anything other than ensure they have adequate contact hours based on the certificates held. The operator will receive a notice via email or regular mail noting this.

Also please note that the certification classes offered by South Dakota Rural Water are still free and supported by a contract with DANR.

The three year period runs from February 1 of the renewal year back to February 1 three years previous. For example, for the 2022 renewal only the contact hours acquired between February 1, 2019 through February 1, 2022 are considered.

For Study materials, visit: www.abccert.org/testing_services/ExamReferences.asp
For more information contact SDARWS Trainer Jim Zeck: 605-201-9568 or jzeck@sdarws.com
REGISTER FOR CLASSES ONLINE: sdarws.com/certification-classes.html

engineering
a better
community

water | wastewater

Mni Wasté Water Supply Project | Cheyenne River Sioux Reservation | North Central SD

Brookings | Sioux Falls | Vermillion | Rapid City | Milbank
605.692.6342 | Toll Free 1.855.323.6342
www.bannerassociates.com

BANNER
engineering a better community

DAKOTA PUMP INC.

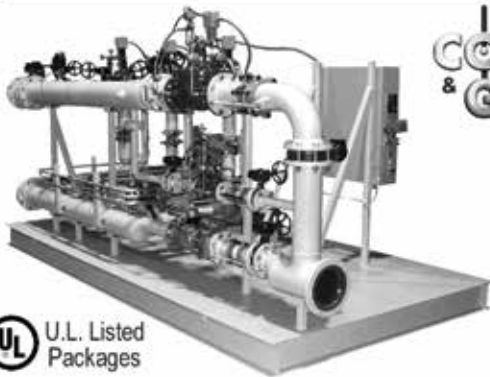

CONNECT
& **GO** Technology

UL U.L. Listed
Packages

Sewage Pump Stations

Wet Well Mounted Lift Stations
Flooded Suction Lift Stations
Self-Priming Lift Stations
Obround Package Pump Stations



The Total Solution

Water Pump Stations

Modular Water Booster Stations
Grade Mounted Water Booster Stations
Water Booster Pump Stations
Water Control Vaults

Why Prefabricated?

Fully factory tested
Ease of installation
Simplified design
Single source responsibility



Dakota Pump Offices:

po box 947 ~ 25524 413th Ave ~ Mitchell, SD 57301 ~
ph.605.996.6636 ~ fax. 605.996.6067 ~ dakotapump.com



SDARWS STAFF DIRECTORY



KURT PFEIFLE

Executive Director

kpfeifle@sdarws.com
605-204-0125



STEVE ATTEMA

Training Specialist

sattema@sdarws.com
605-270-1766



JIM ZECK

Training Specialist

jzeck@sdarws.com
605-201-9568



MIKE MOELLER

*Technical Assistance
Training Specialist*

mmoeller@sdarws.com
605-270-4989



NICK JACKSON

West River Circuit Rider

njackson@sdarws.com
605-641-4557



GREG GROSS

East River Circuit Rider

ggross@sdarws.com
605-201-6026



ROBYN BROTHERS

Office Manager

rbrothers@sdarws.com
605-556-7219



JEFF FOSSUM

East River Circuit Rider

jfossun@sdarws.com
605-201-9561



JEREMIAH CORBIN

*Source Water Protection
Specialist*

jcorbin@sdarws.com
605-270-3894



BILL THORSON

*Technical Assistance
Training Specialist*

bthorson@sdarws.com
605-201-0170



JENNIFER BAME

*Communications &
Marketing Coordinator*

jbame@sdarws.com
605-556-7219



DANNY AYERS

*East River Wastewater
Technician*

dayers@sdarws.com
605-291-2299

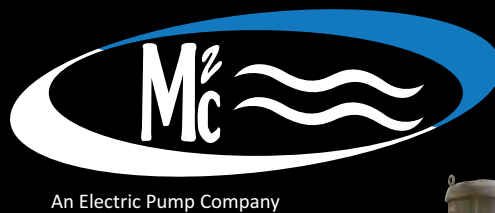

800-211-6432
www.electricpump.com

115 Lipton Street
 Suite B
 Tea, SD 57064

402-333-9660
www.mc2h2o.com

FLEET Program



- The National Rural Water Association has created partnerships with motor groups to offer discounts to State Rural Water Associations and their utility system members.

- Member utilities should contact their State Rural Water Association to access the Rural Water Fleet Program.



SDARWS Conferences & Events



Leadership Seminar | November 17-18, 2021

This seminar is geared towards Rural Water System Directors and covers a gamut of topics pertaining to rural water boards.

For more information, visit www.sdarws.com/leadership.html or email jcorbin@sdarws.com

Pierre Ramkota Hotel & Convention Center
920 W Sioux Ave. • Pierre, SD • 605-224-6877



Annual Technical Conference | January 11-13, 2022

The ATC is the annual conference of the South Dakota Association of Rural Water Systems, and is the largest water/wastewater conference in South Dakota. This event is designed to bring together water and wastewater utility systems – both large and small, municipal and rural – for sessions in operations, management, boardmanship and governance. This conference is held every year during the first week of the South Dakota Legislative session in Pierre, SD and hosts over 500 attendees.

To learn more, visit www.sdarws.com/annual-conference.html or email atc@sdarws.com

Pierre Ramkota Hotel & Convention Center
920 W Sioux Ave. • Pierre, SD • 605-224-6877



Rural Water EXPO | April 27-28, 2022

The EXPO is open to all water and wastewater utility staff, board/council members, engineers, State and Federal employees. The training will consist of twenty presentations, 30 minutes each, thus allocating ten contact hours for those individuals who are licensed operations specialists. Along with the training sessions, the EXPO will showcase many of our industry's manufacturer and supplier leaders. Many will be displaying the recent advances in technology our industry has witnessed over the past several years.

To learn more, visit www.sdarws.com/rural-water-expo.html or email expo@sdarws.com

Rapid City Ramkota
2111 N Lacrosse Street • Rapid City, SD • 605-343-8550



Rural Water Fishing Tourney | April 29-30, 2022

The Annual Rural Water Warriors Fishing Tournament takes place at the Outpost Lodge on Cow Creek Bay in 2022. Teams consist of 2-3 people with at least one person who is a current water/wastewater, associate member or corporate partner of the SDARWS. This tournament is limited to 50 teams. There is an eight fish maximum per boat with the largest seven fish weighed, and all South Dakota fishing regulations must be followed. A mandatory rules meeting is held at 8:00pm the night before the tournament.

For more information, visit www.sdarws.com/fishing-tournament.html or email fishing@sdarws.com



Rural Water Open Golf Tourney | July 19, 2022

The Annual Rural Water Open will take place at the Elmwood Golf Course in Sioux Falls. This tournament is open to Utility Members, Associate Members, and Corporate Partners of SDARWS. Registration is \$75/player and includes golf, cart, lunch, and awards.

For more information, visit www.sdarws.com/golf-tournament.html or email golf@sdarws.com

Elmwood Golf Course
2604 W. Russell St • Sioux Falls, SD • 605-367-7092



Chemicals, Equipment and Service for Safe, Clean Water



Celebrating over 80 years of serving our customers!

WATER TREATMENT

- Potable Water
- Raw Water Clarification
- Swimming Pools
- Wastewater Treatment
- Bioaugmentation Solutions
- Sludge De-Watering
- Waste Settling Aids
- Collection Systems

EQUIPMENT

- Chemical Injection Pumps
- Control and Monitoring Systems
- Chlorination Control Systems
- Chemical Feed Equipment

Black Hawk, SD
605-787-6881

Sioux Falls, SD
605-368-5793

Fargo, ND
701-293-9618

Washburn, ND
701-462-8588

800.328.5460

www.hawkinsinc.com

email: wtg@hawkinsinc.com

SPN & ASSOCIATES

ENGINEERS SURVEYORS GIS SERVICES

Schmucker, Paul, Nohr and Associates

2100 N. Sanborn Blvd – PO Box 398
Mitchell, SD 57301
Phone (605) 996-7761
FAX (605) 996-0015
www.spn-assoc.com

Water • Wastewater • Storm Water • Streets
Airports • Solid Waste • Animal Waste
Land Surveying • Site Development
Geographic Information Systems (GIS)



**ENGINEERING EXCELLENCE
SINCE 1961**



SOUTH DAKOTA RURAL WATER'S ANNUAL TECHNICAL CONFERENCE

CALL FOR PAPERS

The South Dakota Association of Rural Water Systems is looking for presentations for our 2022 Annual Technical Conference in Pierre, SD January 11-13, 2022.

Please submit your abstract for SDARWS' 2021 ATC. Presentation themes may include, but are not limited to the following:

- Drinking water security strategies and tools
- How Water Storage Can Impact Water Quality
- Fair Labor Standards Act
- Hands-on sessions:
 - ◆ Control valve repair kits
 - ◆ Hydrant maintenance and repair
 - ◆ Solution pump repairs (diaphragm and peristaltic)
 - ◆ Repair couplers, saddles, wet tapping
- The importance of Cross Connection Control
- Water Rights for public systems
- Ice Pigging to clean water and sewer pipelines
- Source water protection and sustainability of water supplies
- Climate change, water and energy efficiency, and conservation
- Clean Water Act/SDWA connections, nutrient pollution, and Harmful Algal Blooms (HABs)
- Emerging drinking water treatment technologies and optimization of current technology
- State revolving loan fund tools and techniques/ green infrastructure strategies
- Small systems: TMF, sustainability strategies, technologies, and compliance
- Trench Safety

- Data management (e.g., SCADA, GIS, IT)
- Workforce, operator certification, and/or technical assistance initiatives
- Distribution system issues
- Emerging contaminants in drinking water, both chemical and microbial
- Drinking water research
- Sanitation and wastewater management
- Risk assessment, risk communication and consumer outreach
- Implementation of regulations – challenges and successes

If you would like to make a presentation, please submit a one-page abstract with the proposed presentation title, and the name, title, affiliation, and contact information for the speaker to:

South Dakota Association of Rural Water Systems
PO Box 287
Madison, SD 57042
or email ATC@sdarws.com by September 24, 2021!

OR SUBMIT ONLINE AT
<https://tinyurl.com/ATCAbstracts>

ALL SUBMISSIONS MUST COMPLY WITH THE FOLLOWING GUIDELINES:

1. Deadline for submissions is September 24, 2021
2. Abstract submissions are limited to text only.
3. The conference planning committee will select submitted abstracts for sessions.
4. Please include a five sentence biography along with a 500 word abstract or description of your presentation.

South Dakota Rural Water AWARD NOMINATIONS

Do you know someone who is doing a great job? Goes above and beyond the call of duty? Has your water system achieved excellence this year – or has overcome some amazing challenges?

Give recognition where it is due by making an award nomination. Awards will be presented at the Awards Brunch at the ATC – January 13, 2022. **Application deadline is October 29, 2021.** Eligible nominees must be affiliated with a system member in good standing. The online form can be found at www.surveymonkey.com/r/ATCAwards.

WE ARE ACCEPTING NOMINATIONS FOR THE
FOLLOWING CATEGORIES:

Rural Water System of the Year: Recognition for a member system who puts forth exceptional efforts to properly manage, operate, and maintain their drinking water system.

Rural Water Manager of the Year: Recognition for a manager of a Rural Water System for outstanding performance in operating a Rural Water System.

Rural Water Office Person of the Year: Recognition for an administrative employee of a Rural Water System for outstanding performance in office management and procedures.

Rural Water System Operations Supervisor of the Year: Recognition for a State of South Dakota Certified Operator who is actively working a supervisory role for a Rural Water System, and has demonstrated outstanding leadership ability and/or accomplishments in drinking water.

Rural Water System Operations Specialist of the Year: Recognition for a State of South Dakota Certified Operator who is actively working for a Rural Water System with outstanding leadership ability and/or accomplishments in drinking water.

Municipal Water/Wastewater System of the Year: Recognizes a municipality who puts forth exceptional efforts to properly manage, operate, and maintain their drinking water and wastewater system.

Municipal Manager of the Year: Recognition for a municipal manager for outstanding performance in managing a municipality.

Municipal Office Person of the Year: Recognition for an administrative employee of a municipality (i.e. clerk, finance officer, etc.) for outstanding performance in office management and procedures.

Municipal Operations Specialist of the Year: Recognition for a State of South Dakota Certified Operator who is actively working for a municipality with outstanding leadership ability/accomplishments in water.

Spirit of Rural Water: This award is presented to an individual, business or group that goes above and beyond for a rural water system or rural water cause. South Dakota Rural Water wants to recognize exceptional rural water advocates that stand out from the pack because of their commitment to rural water issues and/or their passion for the job. Eligible candidates include rural and community water consumers, employees, directors, as well as lawmakers, businesses, or any person or group that puts forth a noble effort to advance rural water.

Donald B. Pospishil: This award honors the work of Don Pospishil who dedicated many years of his life to helping small water systems across South Dakota. The Donald B. Pospishil Award is awarded to individuals who demonstrate leadership abilities in the water supply field, provide quality services to consumers, and exhibits professionalism and dedication while operating and maintaining a small water system.



SDARWS' 35TH ANNUAL RURAL WATER OPEN

Jeremiah Corbin,
SDARWS Source Water Protection Specialist

The 2021 rural water open was a grand event for all involved. A field of 197 helped make the 35th annual Rural Water Open a success on July 20. A few adjustments were required to pull the event off, but all in all, the changes were well received, and many will be incorporated into future opens.

A carryover from the COVID accommodations last year, the Rural Water Open utilized tee times, replacing the traditional shotgun start. Teams were sent out on the East, North, and West Nine every seven to eight minutes starting at 8:30. The last teams hit the course at 10:37. The WaterPac challenges returned this year, with On-The-Green challenges on both #8 East and West. The 19th hole putt challenge also returned, and we again pre-sold Mulligans (at a discount) and made available the day of the open. The mulligans raised \$2,650 for WaterPac. The on the green challenge raised \$2,010 and the putt challenges raised another \$460. All told, \$5,120 was raised for WaterPAC, making this the most successful WaterPac fundraiser for South Dakota Rural Water. Thanks to Direct Automation, Metering and Technology Solutions, and Bartlett & West for sponsoring this year's WaterPac Kegs.

The field of 50 teams once again brought out an array of talent. Scores were competitive this year with the majority of teams posting scores below par. Scores ranged from 18 under to ten over. Due to the nature of the dynamic field, scoring was based on score under or over par based on the particular 18 holes a team played. Also, tiebreakers were decided by hole handicap and final rulings were determined by the club professional, Chad Veire. The mulligans did influence scores, as would be expected; the winning team purchased four. Thanks go out to the Corporate Partners that helped make this event possible – they are listed on page three. Without their support it would

be impossible to provide this event at the level that competitors have come to enjoy.

Following Rural Water Open traditions, the tournament format included four-person teams playing an 18-hole scramble with no championship or amateur division. After the scores were posted and verified by the club pro Chad Veire, all team scores were listed from lowest to highest, and then the field was split into quarters with about 12 teams in each of the four flights. To summarize, the 1st flight teams ranged from -18 to -8; 2nd flight ranged from -7 to -4; the 3rd flight ranged from -3 to -1 and the 4th flight ranged from even par to +7. The top placing teams are listed on page 18.

One of the most popular changes from last year was brought back, the box lunches. These unique meals offered a beef tenderloin sandwich, potato salad, a bag of chips, and a cookie. Competitors were able to pick these lunches up at the clubhouse as they made the turn for their second nine holes or enjoy at the end of their round. We decided to feed the competitors during the event because we did not hold an awards ceremony at the end of the event. Prizes were sent out to winners after the conclusion of the event.

Additionally, a Big THANK YOU to Brosz Engineering for sponsoring golf balls, Hawkins for sponsoring the Flyboy coffee and donuts, and SVEN for sponsoring the Cart GPS.

In conclusion, we would like to thank all the sponsors, participants, and volunteers who helped make this event successful. Golfers, please remember to check out our Corporate Partners on page three and when they stop by your facility let them know you appreciate their generosity and continued support.

Mark your calendars for the 2022 Rural Water Open, it is scheduled to take place on July 19, once again at Elmwood. ♦



2021 RURAL WATER OPEN STANDINGS

1ST FLIGHT WINNERS

- 1st** – Banner: Sid Munson, Kolby Newborg, Eric Munson, Keeton Newborg (53)
2nd – Sioux Falls: Gavin Graverson, Greg Stahl, Kenny Hartzell, Jerry Adler (56)
3rd – HDR/Tea: Jason Kjenstad, Dawn Murphy, Colin Murphy, Kevin Nissen (57)
4th – Grant Roberts / DGR: Dan Nebelsick, Tom Frogner, Lance Frogner, Mike Paulson (59)
5th – Maguire Iron 1: Brian Cooper, Matt Neff, Troy Werdel, Dan Engelsman (60)

2ND FLIGHT WINNERS

- 1st** – Banner 3: Joe Munson, Taylor Fauth, Jon Hauge, Mike Wendland (64)
2nd – Core & Main: Dustin Sulzle, Chad Hanson, Duane Walters, Cody Fransen (64)
3rd – Malloy: Todd Olmschenk, Colin Bretsch, Jon Nelson, Ed Armit (64)
4th – Farrell, Al & Shelby: Farrell Anderson, Al Schlaikjer, Shelby Bierema (64)
5th – Harrisburg: Nolan Meyer, Chris Kullander, Joe Stonesifer, Cole Wedel (64)

3RD FLIGHT WINNERS

- 1st** – Banner 2: Waylon Blasius, Weston Blasius, Wade Blasius, Tim Pringle (68)
2nd – Maguire Iron: Chad Edwards, Scott Jones, Corey Sanders, Rich Kemmis (68)
3rd – Vessco: Matt Madson, Andy Hanson, Caleb Musick, Patrick Bunkers (68)
4th – Big Sioux Crew: Aric Olson, Grace Johanson, Lehni Olson, Taylor Bult (68)
5th – MCWC 2: Ben Meyer, Tom Van Well, David Fox, Greg Schmidt (68)

4TH FLIGHT WINNERS

- 1st** – HDR A Team: Kevin Neuman, Ben Schultz, Casey Volker, Delron Peters (71)
2nd – TM RWD: Gregg Jorgenson, Jay Jorgensen, Greg Nugteren, Dennis Johnson (71)
3rd – The Rush: Megan Bergin, Rebecca Qualm, Deryn Beck, Stephanie Grey (73)
4th – RCWD 1: Ricky Bergin, Jordan Kocer, Chancey Shrake, Jason Wright (73)
5th – L&C 1: Lori Seten, Justin Walsh, Tim Conner, Tom Erickson (73)

LAST PLACE

Last – RCWD 1: Mason Wright, Grant Petrik, Corey Debey, Chris Van Schepen (81)

Last place received fishing poles and tackle cases donated by JCG Land Services

FLAG PRIZE WINNERS

- Closest to the Pin #4:** Clay Ricks – \$100 Visa Gift Card
Longest Drive #7: Barry Berg – \$100 Visa Gift Card, & Assorted merchandise donated by Hawkins
Longest Putt #9: Steve Muilenburg: \$100 Menards Gift Card, & 4 bag chairs for the team donated by DGR Engineering
Closest to the Pin #12: Grace Johanson – \$100 Visa Gift Card
Longest Drive #16: Kenny Hartzell – \$100 Visa Gift Card, & Assorted merchandise donated by Hawkins, Inc.
Longest Putt #17: Brad Carstensen – \$100 Scheels Gift Card, & 4 golf towels for the team donated by Bartlett & West
Closest to the Pin #E5: Delron Peters – \$100 Visa Gift Card
Longest Drive #E7: Nolan Meyer – \$100 Visa Gift Card
Longest Putt #E9: Lehni Olson – \$100 Visa Gift Card donated by Malloy Electric

CHALLENGE HOLE WINNERS

- On The Green #8W:** Jake Fitzgerald – \$100
On The Green #8E: Sam Johnson – \$100
Putt Challenge - 3 Putts In: Todd Syhre - \$200
Putt Challenge - 2 Putts In: Jeff McCormick - \$100
Putt Challenge - 1 Putts In: Sid Munson - \$50



THANK YOU TO THIS YEAR'S RURAL WATER OPEN SPONSORS

KEG SPONSORS

Bartlett & West



COFFEE & DONUTS



BALL SPONSOR

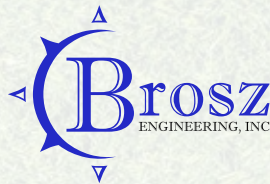

GPS SPONSOR



HOLE PRIZE SPONSORS



GOLD LEVEL TEE BOX SPONSOR



BRONZE LEVEL TEE BOX SPONSOR

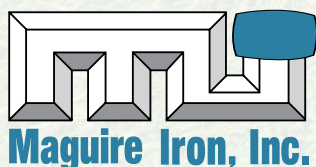

The Leading Distributor of Water, Sewer & Storm Drain Products & Services



WE'RE ALL ABOUT

South Dakota

When you need dependable service in the middle of the night, the eye of the storm or the center of town, you need the waterworks experts at Core & Main.

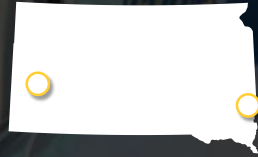

Sioux Falls
2101 E 54th St N
(605) 339-2814

Rapid City
2808 E Highway 44
(605) 716-9427

- FUSIBLE PIPING
- METERING AMR/AMI
- TREATMENT PLANTS
- STORM DRAIN PUMPING

Local Knowledge | Local Experience | Local Service, Nationwide®

coreandmain.com

PASD20190529



Bartlett & West

Engineering water solutions for community growth.

Clean, safe and reliable water is a basic building block of a modern community. Residents and industry depend on your system. You need proactive communications regarding system needs and innovative, comprehensive solutions. As a national leader with long-time relationships in water-focused services, Bartlett & West is your ally for success.

5900 S. Western Ave., Ste. 101 ■ Sioux Falls, SD
(888) 200-6464 ■ www.bartlettwest.com

THE COST OF DOING BUSINESS



Bill Thorson, Technical Assistance Training Specialist

I recently attended a Disaster Preparedness Training school in Texas where each of us attending had the chance to converse with other state association employees. I was enlightened about how vital training and, more importantly, good training can be hard to come by. The South Dakota Legislature and the Department of Agriculture and Natural Resources recently adjusted the testing costs for water and wastewater operational specialists from ten dollars to sixty dollars. For many years, the price has been ten dollars per test with a six-dollar renewal fee each year, with the rest of the costs subsidized by SD DANR. Many say that a six-fold increase in the testing cost is a bit high, but the new fees do not include the six-dollar renewal fee. The SD DANR also covers the cost of classes that SDARWS put on for certification. Before you turn the page, as you already know all of this, let me show you what other states around us charge and what level of training you get with that cost.

Our neighbors to the east in Minnesota charge \$32 per test, and some of the training class costs range from \$40 for online to \$400 for in-person. If you pass, you send a \$23 certification fee to the department for the certificate. The Minnesota Pollution Control Agency does the training classes for wastewater, and the Stabilization Pond class is five days long. Training hours must consist of 50 percent of actual water or wastewater material approved by the department of the appropriate agency. The wastewater tests cost \$55 each. If you do not pass a test, you cannot take the same test for 90 days.

In Nebraska, a certification test will cost you between \$80 and \$200 each for the initial application and license, including a two-day to five-day class, depending on the level needed. You

are also required to buy the books, which is another \$90. Each retake test is \$50. Renewals are \$115 unless your certification lapsed, then add \$35. The current passing rate is less than 30 percent. That means some operators are taking the same test four or five times.

Alaska is at \$150 for each test, both water, and wastewater. Once a test is passed, the application for certification is \$100, and a renewal is \$100. An expired certificate will cost \$150, while a renewal on a suspended certification is \$300. Department-sponsored training is \$150 per day, and a department-sponsored online course will cost \$20 per credit hour plus materials.

With just these few examples, you can see how relatively inexpensive operator certification really is in South Dakota. Thank someone with SD DANR or your local legislative representative for providing the resources necessary to assist you in achieving your operator certification. You still must do the work and pass the test to certify to do your job, but it can lead to a rewarding and satisfying career. With classes now back in person and filling up fast for most dates, don't let your renewal hours get left behind either. As always, stay safe. ♦



BILL THORSON joined the SDARWS staff in March of 2018 as a Wastewater Tech. Bill transitioned to Trainer/Technical Assistance Specialist with SDARWS in October of 2019. Bill previously was employed with the City of Canton as Public Works Director for nine years and water/wastewater operations specialist for 19 years. Bill holds Class II certifications in Water Treatment, Water Distribution, Wastewater Treatment, and Wastewater Collection. Bill is NASSCO certified in pipeline and manhole inspections. Bill is also an SDWWA board member.

When It Comes To Waterworks, There Can Be A Lot of Pressure.



To succeed, you need a partner that makes your job easier. With Dakota Supply Group, you get more than just pipe and products:

- ▶ Contact us today to learn more about how we can help you.

DSG
DAKOTA SUPPLY GROUP
For all the right connections!

FARGO, ND ▶ [800] 342-4676
BISMARCK, ND ▶ [855] 337-9258
SIOUX FALLS, SD ▶ [800] 660-5531
RAPID CITY, SD ▶ [800] 660-5538
BURNSVILLE, MN ▶ [800] 325-0514

www.dakotasupplygroup.com

From our very beginning we've focused on **WHAT'S IMPORTANT...**

To us, your project isn't a job - it's an opportunity to make a positive impact, protect future generations, and ensure the vitality of where we live and work.

THINK BIG. GO BEYOND.



Providing engineering and related services to help clients achieve success.



Advanced Engineering and Environmental Services, Inc.

www.ae2s.com



TIME, TALENTS, TREASURES

Jeff Fossum, Circuit Rider

If you are on the same liturgical calendar as me, you probably had “the talk” a few weeks ago. You know what I am talking about being a good steward. Yes, the one or two Sundays a year, the preacher talks about giving of oneself. On that day at Grand Valley, Pastor Ralfe Johnstad talked about the three T’s Time, Treasure, and Talents. I was left thinking about how this compares to my daily thought and work.

TIME

How many times per day do you say when I have time I will...? Or When time permits I will? Or later this week, I should have time to... We all have the same 24 hours in the day, just like everyone else. How do you spend that time? Do you plan what needs to get done and work from top to bottom? Or do you work on the hot topics giving the squeaky wheel the grease? For what are we using all the time we have? The average person sleeps just under 7 hours, down more than an hour since 1942. The rest of your 24-hour day is filled with work, taking care of the kids, eating, and all the stuff you need to do to keep the family moving forward. According to www.inc.com/jeff-haden that leaves us men with 5 hours, 56 minutes, and women with 5 hours, 18 minutes of leisure time every day. The main thought is to take just 30 minutes a day - which averages out to 180 hours in a year, to volunteer or give your time to improve your community!

TALENTS

What are our talents? Some of us can sing, while others should just mouth the words and hum along - even if it is one of our favorite songs. Is your talent growing a crop or livestock to feed the world? Maybe your talent is the ability to take a community of people and blend the ideas into a vision to build a water system from nothing but a want and a dream.

At this point in the church service, Pastor Johnstad had everyone comfortable in the pews talking about what we could do with our hands.

TREASURES

But this next one gets a little touchy. Yes, he was getting to the part of the sermon that makes both the preacher and the parishioners both very uncomfortable. Now I get on a soapbox about how selfish we as an individual have gotten. What is in it for me?! I deserve to be compensated! I do not want my money to go for building that!

I look back at our ancestors that settled this great state of South Dakota. They left a place called home, leaving friends and family to come to this place and made us a place to call home from scratch. No roads, no nothing but a want to build a good place to call home. The big box stores were not on every corner of the large town next door. Our ancestors had to use their Three T’s. I get excited when I hear people act like our ancestors and say, “as long as its for the best of everyone, ok!”

Now, what is your excuse! Start today with a challenge of giving 30 minutes a day to share to make the best use of your Three T’s: Time, Treasure, and Talents for the betterment of the place we call home. 💧



JEFF FOSSUM joined the SDARWS staff in February 2018, as a Circuit Rider. He previously worked for 32 years at the City of Canton, SD as the Water/ Wastewater Superintendent. Jeff holds a Class II Water Treatment, Class II Water Distribution, Class II Wastewater Treatment and Class II Wastewater Collection. His interests include gardening, woodworking and talking.



ISG

Sustainable Water Solutions

Protecting the reliability, quality, and availability of your community's water supply.

Architecture + Engineering + Environmental + Planning | ISGInc.com | 605.274.6401



INDUSTRY LEADING BRANDS FROM THE INDUSTRY LEADING SUPPLIER.

We carry cutting-edge metering technology—capable of not only monitoring regular water usage, but identifying major leaks, backflow and potential tampering. To save time, money and resources, trust in metering solutions from Ferguson Waterworks. **For more information, email meters@ferguson.com**



 NEPTUNE
TECHNOLOGY GROUP

 **FERGUSON**
WATERWORKS

BISMARCK | FARGO | SIOUX FALLS
FERGUSON.COM/METERS

• **LARGE LEAK DETECTED**

© 2020 Ferguson Enterprises, LLC 02201773833

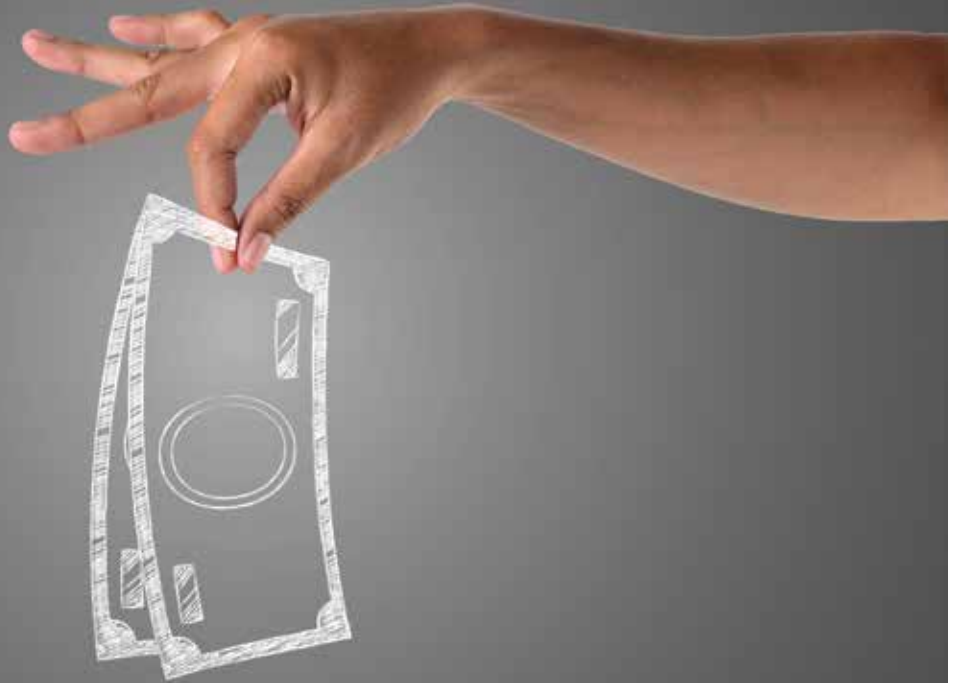

WHO CARES ABOUT MONEY?

Greg Gross, Circuit Rider

Now that I have your attention, who does care about money? This past June, I attended the National Rural Water Association in-service event in Orlando, FL. One of the training sessions was about training up new employees and letting go of the reigns as older employees. To start the presentation, Mr. Don Van Veldhuizen asked the class how important is money (pay) to today's employees. The entire class was surprised to learn that money was number four in order of importance.

THIS IS WHAT IS IMPORTANT TO EMPLOYEES TODAY:

- #1 **Appreciation**
- #2 **Job Satisfaction**
- #3 **Benefits**
- #4 **Pay**

Let that sink in for a little bit. Letting your employees know they are important is more valuable than money. One of my favorite work experiences was a welding shop that was either too hot or too cold. It could be smoky or poor lighting. It was some of the hardest physical work I have done, but my favorite job for some reason. Was it the people, the pay, or the type of work? I really hadn't thought about it until looking at this list. The owners of the company would regularly come out to the shop. Of course, they wanted to see how production was going, but they would take the time to stop and ask employees how they were doing and knew about important things in each employee's life. A bond was built by indirectly telling each person that they were important to the company as both an employee and as a person. One hot summer day, one of the bosses started walking through the shop handing out ice cream sandwiches. It wasn't break time; he just wanted everyone to stop what they were doing and take a cooling break with ice cream. Ice cream was not something that was just lying around the office. A conscious effort was made to

do something unexpected for each employee. It didn't cost a great fortune, it was the thought that held the greatest value.

That whole paragraph was to lead you all to this point. Over the past four years, I have seen many great city employees leaving the field because of point number one. City maintenance workers are not "a dime a dozen." Most cities have one employee (if they can even afford that). To be certified as a water and wastewater operator requires passing up to five tests just for small systems. Add in swimming pool operations, mosquito test, machine calibration, three tests for weed spray applications. A city's maintenance person must be someone that can work on their own, see problems before they arise and be quick to diagnose problems when they do. They wear many hats and are seldom recognized for all that they contribute. Does anyone notice that they were up at 4 am plowing snow? Do they get any recognition for working on the lift station from 11 pm till 1 am so that basements don't get flooded with raw sewage? Animal control, code enforcement, lawnmower guy, rubble site management, pothole filler, dead animal remover, meter reader and replacer, snow removal, mechanic, welder, fence fixer, how many people can do all these things. "A dime a dozen" is the biggest insult and lack of appreciation anyone can do or say to an employee.

Whether you are hiring or just maintaining employees, remember #1 and #2 on the list, and the rest will fall into place. A happy person is a productive person. 💧



GREG GROSS joined SDARWS in March 2017. Greg currently holds South Dakota certificates for Class I wastewater, Class I Water Distribution, Class I Wastewater Collection and Class I Stabilization Pond. Greg's work experiences include, Utilities manager in Howard for 2 years, City maintenance worker in Alexandria for 2 ½ years, and Welder/builder of water booster and sewer lift stations at Dakota Pump of Mitchell for over five years.

“We love our new website! This is the best decision we ever made!”



RuralWaterImpact.com

Smart Websites for Smart Water Systems™

MunicipalImpact.com

Smart Websites for Smart Communities™



NRWA
Official Partner

Trusted website provider for more than 1,400 small towns and water systems across America!

Text Alerting System • Easy Updates • Secure Hosting • Free Trial • Unlimited Support • Money-Back Guarantee

FAST LAUNCH: Get a Website in Just 3 Days! Call Today (888) 551-4815



The Power of Association

Only the National Rural Water Association can bring together this unique Products & Services Portfolio designed to meet the needs of utilities.

Call 800-545-1054 for more information or visit nrwa.org!

*Availability may be limited in some states.



SINCE 1893

THEIN WELL

- WELL DRILLING
- PUMP SALES/SERVICE
- WELL REHABILITATION
- WELL ABANDONMENT
- GEOTHERMAL
- WELL TELEVISION
- GEOPROBING
- SOIL BORINGS
- MONITOR WELLS
- REMEDIATION WELLS
- ROCK CORING
- GAMMA/Gamma Logging

24 Hour Emergency Service

1-800-450-8000

www.theinwell.com





HRGreen®



Providing water and wastewater services for more than a century.

▷ 431 N. Phillips Ave, Suite 400
Sioux Falls, South Dakota 57104-5933
Phone 605.334.4499

▷ HRGREEN.COM

TRANSPORTATION + WATER + GOVERNMENTAL SERVICES
LAND DEVELOPMENT + ENVIRONMENTAL + CONSTRUCTION

STRUCTURE.
& INTEGRITY.

**PITTSBURG
TANK & TOWER
GROUP**

An ESOP Company Since 1919
"100 years and still climbing"

**CREWS
AVAILABLE
GLOBALLY**



www.pttg.com



INSPECTIONS REPAIR TANKS



Wet	Code	Elevated
Dry	Updates	Ground
ROV	Paint	Relocation
In-Service	Insulation	Erection
Cleaning		Dismantles

NEW TANKS - Rick DiZinno
(270) 826-9000 ext. 2601

EXISTING TANKS - Jordan Pyles
(270) 826-9000 ext. 4601

MIDCONTINENT

TESTING LABORATORIES, INC.

- State-certified for **DRINKING WATER** and **WASTEWATER** testing
- Custom pre-printed sample forms save you time
- Setting the pace for analytical testing & customer service
- Our batch SOC testing can save you \$\$\$ in testing costs
- **FAST SERVICE!** Check your results online by logging on @ www.TheChemistryLab.com



2381 S. Plaza Drive P.O. Box 3388 Rapid City, SD 57709
Phone 605-348-0111 • FAX 605-721-0265

FORD Secura-Lok
INTEGRATED VALVE LOCKS BY
FORD METER BOX



- LOCK OPERATIONAL
- LOCK OPEN
- LOCK CLOSED

260-563-3171
fordmeterbox.com

CLOGGED PUMPS?

Tackle wipes and large debris with these solutions from USABlueBook!

FOR SMALLER APPLICATIONS AND LIFT STATIONS

FlowRake Rag Catchers

USABlueBook
EXCLUSIVE

OPERATOR
DESIGNED



FOR LARGE MUNICIPAL LIFT STATIONS

StationGuard Manual Bar Screens

OPERATOR
DESIGNED



We also offer non-clog sewage and chopper pumps.
LEARN MORE! usabluebook.com/NoMoreClogs

USABlueBook[®]
GET THE BEST TREATMENT™

800.548.1234 • usabluebook.com



We help protect your personal information from getting into the wrong hands.

IDShield Plan Benefits:

- \$1 Million Protection Policy
- Unlimited Service Guarantee
- Identity, Credit, Social Media Monitoring, Plus Real Time Alerts
- Username and Password Combination Monitoring – *ONLY AVAILABLE WITH IDSHIELD!*
- Full-Service Identity Restoration
- Child Monitoring (Family Plan only)
- 24/7 Emergency Access

www.legalshield.com/info/sdrws



Identity Theft Services at Your Fingertips

With the IDShield Plus mobile app you can track your alerts, check your credit score and have on-the-go access 24/7!







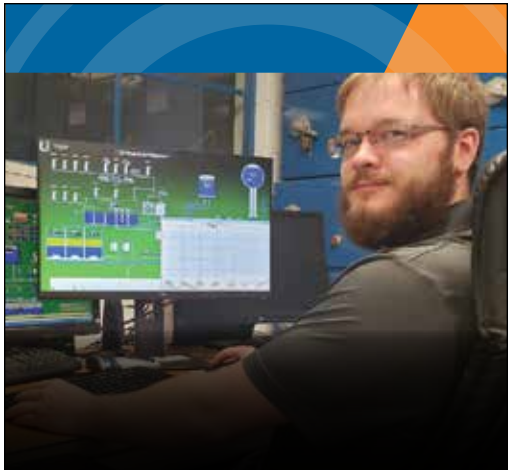

CERTIFICATION PRACTICE QUESTIONS

- What is the primary origin of coliform bacteria in water supplies?
 - Natural algae growth
 - Industrial Solvents
 - Animal or human feces.
 - Acid Rain
- Which of the following chemicals is used to soften water through chemical precipitation?
 - Calcium Hydroxide
 - Calcium Bicarbonate
 - Calcium Chloride
 - Calcium Sulfate
- Which of the following chemicals decreases corrosion rates?
 - H₂S
 - CO₂
 - CaCO₃
 - O₂
- Which of the following should be used by an operator to test for residual chlorine?
 - DPD (N, N-diethyl-p-phenylenediamine)
 - Cresol Red
 - Methyl Orange
 - Sulfuric Acid
- Which one of the following is a major part of a Turbidimeter?
 - Objective nosepiece
 - Reference Electrode
 - Aspirator
 - Light Source
- As water temperature increases, the disinfection action of chlorine will
 - Increase
 - Decrease
 - Double
 - Indeterminate as it also depends on the pH
- The iron content of raw water is 1.81 mg/L. What is the percent removal if the finished water contains 0.11 mg/L iron?
 - 17%
 - 20%
 - 60%
 - 94%
- Alkalinity consists predominantly of which of the following?
 - Bicarbonate, Carbonate, and Hydroxide
 - Carbon Dioxide and Bicarbonate
 - Carbonate and Carbon Dioxide
 - Carbonate, Carbon Dioxide and Bicarbonate
- Under the surface water treatment rule, what is the log removal or inactivation required for viruses?
 - 1.0 log
 - 2.0 log
 - 3.0 log
 - 4.0 log
- Which of the following will most accurately measure 500 ml of solution?
 - 500 ml beaker
 - 500 ml Erlenmeyer flask
 - 500 ml graduated cylinder
 - 500 ml volumetric flask



NEED TO KEEP THE WATER FLOWING?

THOMPSON KNOWS AUTOMATION

-  System Design & Engineering
-  UL Certified Custom Control Panel Fabrication
-  SCADA/HMI Systems Development
-  Maintenance Service Hardware/Programming



THOMPSON

CALL TODAY!

866.258.8462

thompsonknows.com
automation@thompsonknows.com

ELECTRIC · LIFE SAFETY · AUTOMATION · IT & SOFTWARE

1. C; 2. A; 3. C; 4. A; 5. D; 6. A; 7. D; 8. A; 9. D; 10. D

EFFECTIVE SOLUTIONS TO REDUCE WATER LOSS.

Make us prove it.

Our enterprise solutions can not only handle your customer management and billing, accounting and work management needs, when paired with our other solutions like UtiliSuite GIS and Orbit Meter Data Management, we can help you identify and locate water leaks, meter inaccuracies, unauthorized consumption, billing errors and more.



Intelligent Solutions for Tomorrow's Utilities



**Professional
Computer
Solutions**



Nate Houston
Regional Business Developer
nate.houston@pcs-csa.com

888-843-3106 • www.pcs-csa.com



Bridging the gap
between idea +
achievement



Sioux Falls 605.977.7740
Rapid City 605.791.6100

hdrinc.com

Onida Man Chosen To Head USDA Rural Development Community Programs In SD

The U.S. Department of Agriculture Rural Development is pleased to announce that Brian Ring has been selected as the new Community Programs Director in South Dakota (effective July 18, 2021).

Brian has been with USDA for more than 31 years and has worked in a majority of Rural Development's programs at one time during his tenure which began with Farmer's Home Administration in the Milbank and Chamberlain county offices. Brian has held several positions during his federal career including Assistant County Supervisor, County Supervisor, Community Development Manager, Area Coordinator, and most recently as a Commercial Loan Specialist serving the Pierre area. Brian is also the State National Association of Credit Specialists President for South Dakota. He resides in Onida, South Dakota with his wife Sheila, and has two grown children, Lyndsey and Cordell.

"On behalf of the USDA Rural Development South Dakota staff and myself, we congratulate Brian on his promotion to Community Programs Director," said USDA Rural Development Acting State Director Hally Witte. "His years of experience working with Rural Development programs and South Dakotans make Brian a great asset to the leadership team as we work towards building back better together."

You may contact Brian at 605-301-3411 or brian.ring@usda.gov.

RURAL DEVELOPMENT'S COMMUNITY PROGRAMS IS COMPRISED OF:

Community Facilities Programs offer direct loans, loan guarantees and grants to develop or improve essential public services and facilities in communities across rural America. These amenities help increase the competitiveness of rural communities in attracting and retaining businesses that provide employment and services for their residents.

Through Water and Environmental Programs, rural communities obtain the technical assistance and financing necessary to develop drinking water and waste disposal systems. Safe drinking water and sanitary waste disposal systems are vital not only to public health, but also to the economic vitality of rural America.💧

For more information, visit www.rd.usda.gov/sd or call 605-352-1100.



Brian Ring



Your number one source

Top providers of creative water and wastewater solutions with over 75 years of combined experience.



treatmentresources.com • 612 702-2692

QUICK & EASY FINANCING SOLUTIONS



www.cobank.com/h2oloan

844-846-3135

Proud Member of the Farm Credit System 

WHEN YOU
NEED POWER WE
THERE FOR YOU. ARE

NEW OR USED, ANY SIZE OR SHAPE,
IN ANY REGULATORY ENVIRONMENT

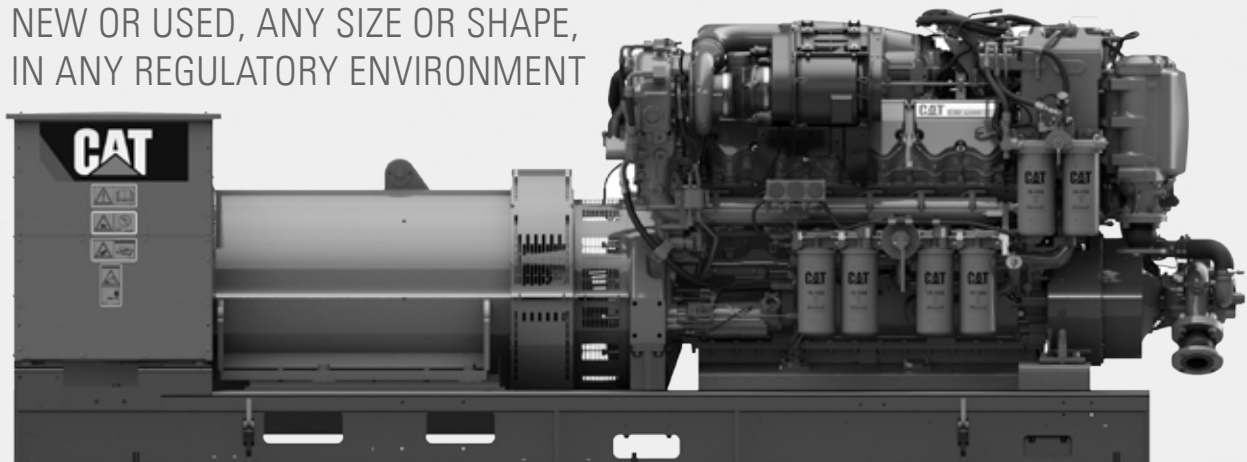

877.365.8114
BUTLERMACHINERY.COM

Butler 

PHOTOS FROM THE FIELD



SDARWS' Circuit Rider Jeff Fossum's granddaughter Skylar looking pretty cute in grandpa's hat.



Locating curb stops can be a challenge... our Circuit Rider Jeff Fossum found this one under a tree while mapping a system!



Here's a throwback from 20 years ago - SDARWS Manager's Meeting at the Thunderstik Lodge in Oacoma (August 2001)



SDARWS Training and Technical Assistance Specialist was recently in Parkston assisting with smoke testing.



To see more pictures of SDARWS in action, follow us on Facebook at www.facebook.com/SDRuralWater



FROM THE EXECUTIVE DIRECTOR

KURT PFEIFLE, EXECUTIVE DIRECTOR



SD Rural Water managers touring Maguire Iron

“Expert” \ 'ek-spərt \

- (1) having or involving authoritative knowledge.
- (2) 50 miles and a briefcase.

Webster defines an “Expert” as “having or involving authoritative knowledge.” I’ll admit I added the 2nd definition, “50 miles and a briefcase!” I made that addition to illustrate a point, that we often miss or fail to consider the experts and excellent resources we have in our own backyards. As human beings, we tend to dismiss the familiar and gravitate to the exotic. In doing so, we potentially miss not only first-rate goods and services but the chance to cultivate a great relationship and friendship with businesses and people who live and are invested in your community or the region.

Recently I joined a group of rural water managers to tour such a local business. Maguire Iron of Sioux Falls manufactures, erects, and maintains elevated water storage tanks for water utilities. Of course, there are other elevated tank manufacturers around the nation, and they all make fine water storage tanks, but here is a premiere tank manufacturer right here in our own state. They are a manufacturer that sets high standards for their products and their service.

There are other businesses in our state that offer unique products and provide much-needed services. Dakota Pump, Inc. is a Mitchell, SD company that manufactures great prefabricated, prepackaged pump stations and other enclosures. Again, others manufacture such stations and do a fine job, but the folks at Dakota Pump are local and heavily invested in the great state of South Dakota.

While singing the praises of a couple of unique and local suppliers like Maguire Iron and Dakota Pump, I’d be remiss if I didn’t also give a shout-out to all of the vendors who are Associate Members of South Dakota Rural Water. Although not all members have headquarters in our great state, they nevertheless invest heavily in South Dakota and South Dakota Rural Water. These dedicated companies support our Association through their membership dues, advertising, conference participation, and at times making outright donations to the cause.

When considering goods and services for your utility, please keep in mind these regional businesses and prioritize those who invest in and support your communities, your state, and your Association! Let them know you are aware of what they do and that you’re appreciative of their efforts to benefit your communities and your Association! 💧



Trusted. Professional. Solutions.

At DGR Engineering, we know about water and how important it is to everyday life. After all, we've been working with it for over 65 years. We provide our clients with solutions they can trust, covering all types of water issues from supply, treatment, storage and distribution, to wastewater treatment, collection, lift station and sewer rehab.

Call us today to discuss solutions for your next project.



Sioux Falls, SD
Rock Rapids & Sioux City, IA
800-446-2531



COMMITTED TO MAKING YOUR WORKPLACE SAFER

We're more than a workers' compensation insurance policy provider. We're your partner in driving injury prevention.

RAS has been the endorsed Work Comp carrier for the SD Rural Water Association for over 10 years.



Our association agency partner:
Justin Overman
Marsh & McLennan Agency, LLC
605.339.3874

RASCompanies.com
800.732.1486



203 W. Center Street
P.O. Box 287
Madison, SD 57042
www.sdarws.com



SOUTH DAKOTA RURAL WATER
**LEADERSHIP
SEMINAR**

2021 RURAL WATER
BOARD TRAINING EVENT

SAVE THE DATE
NOVEMBER
17-18, 2021

RAMKOTA HOTEL, PIERRE, SD

REGISTER ONLINE AT: [HTTPS://TINYURL.COM/SDLEADERSHIP](https://tinyurl.com/sdleadership)